



SPORTON LAB.

Certificate No: EC251724-01

CERTIFICATE

- **EQUIPMENT: 20-Port 10/100/1000Base-T + 4 TP/(100/1G) SFP Combo + 2 (100/1G) SFP L2 Plus Managed Switch**

MODEL NO. : VigorSwitch G2260, VigorSwitch P2261

APPLICANT : DrayTek Corp.

No.26, Fushing Rd., Hukou, Hsinchu Industrial Park,
Hsinchu, 303, Taiwan



I HEREBY

CERTIFY THAT:

THE MEASUREMENTS SHOWN IN THIS TEST REPORT WERE MADE IN ACCORDANCE WITH THE PROCEDURES GIVEN IN **EUROPEAN COUNCIL DIRECTIVE 2004/108/EC**. THE EQUIPMENT WAS **PASSED** THE TEST PERFORMED ACCORDING TO

European Standard EN 55022:2010 Class A, EN 61000-3-2:2006/A1:2009/A2:2009, EN 61000-3-3:2008 and EN 55024:2010 (IEC 61000-4-2:2008, IEC 61000-4-3:2006/A1:2007/A2:2010, IEC 61000-4-4:2004/A1:2010, IEC 61000-4-5:2005, IEC 61000-4-6:2008, IEC 61000-4-8:2009, IEC 61000-4-11:2004).

THE TEST WAS CARRIED OUT ON **Jun. 06, 2012** AT **SPORTON INTERNATIONAL INC. LAB.**

Alex Chen
Q.A Dept. Director

CE EMC TEST REPORT

according to

**European Standard EN 55022:2010 Class A,
EN 61000-3-2:2006/A1:2009/A2:2009, EN 61000-3-3:2008 and
EN 55024:2010 (IEC 61000-4-2:2008,
IEC 61000-4-3:2006/A1:2007/A2:2010, IEC 61000-4-4:2004/A1:2010,
IEC 61000-4-5:2005, IEC 61000-4-6:2008,
IEC 61000-4-8:2009, IEC 61000-4-11:2004)**

Equipment : 20-Port 10/100/1000Base-T + 4 TP/(100/1G) SFP
Combo + 2 (100/1G) SFP L2 Plus Managed Switch

Model No. : VigorSwitch G2260, VigorSwitch P2261

Applicant : **DrayTek Corp.**
No. 26, Fushing Rd., Hukou, Hsinchu Industrial Park, Hsinchu,
303, Taiwan

Statement

- The test result refers exclusively to the test presented test model / sample.
- Without written approval of SPORTON International Inc., the test report shall not be reproduced except in full.
- This test report is only applicable to European Community.

SPORTON International Inc.

6F, No. 106, Sec. 1, Hsin Tai Wu Rd., Hsi Chih, Taipei Hsien, Taiwan, R.O.C.

Table of Contents

History of this test report.....	iv
CERTIFICATE OF COMPLIANCE.....	1
1. General Description of Equipment under Test.....	2
1.1. Applicant.....	2
1.2. Manufacturer	2
1.3. Basic Description of Equipment under Test	2
1.4. Feature of Equipment under Test	2
2. Summary of the Test Result	3
2.1. Emission Tests	3
2.2. Immunity Tests	3
3. Test Configuration of Equipment under Test	4
3.1. Test Manner	4
3.2. Description of Test System	5
4. Test Software	6
5. General Information of Test.....	7
5.1. Test Facility	7
5.2. Test Voltage	7
5.3. Measurement Procedure.....	7
5.4. Test in Compliance with	7
5.5. Frequency Range Investigated	8
5.6. Test Distance	8
6. Conducted Emissions Measurement	9
6.1. Limits for conducted disturbance at mains terminals and telecommunication ports	9
6.2. Description of Major Test Instruments	10
6.3. Test Procedures.....	10
6.4. Typical Test Setup Layout of AC Powerline Conducted Emissions	11
6.5. Typical Test Setup Layout of Disturbance at Telecommunication Ports	12
6.6. Test Result of AC Powerline Conducted Emission	13
6.7. Test Result of Disturbance at Telecommunication Ports	15
7. Radiated Emission Measurement	18
7.1. Limits for radiated disturbance	18
7.2. Description of Major Test Instruments	19
7.3. Test Procedures.....	20
7.4. Typical Test Setup Layout of Radiated Emissions	21
7.5. Test Result of Radiated Emission for Below 1GHz.....	22
7.6. Test Result of Radiated Emission for Above 1GHz	26
8. Harmonic Current Emissions Measurement.....	30
8.1. Standard.....	30
8.2. Test Procedure.....	30
8.3. Test Equipment Settings	30
8.4. Typical Test Setup Layout of Harmonic Current Emissions	30
8.5. Test Result of Harmonic Current Emissions	31

9. Voltage Fluctuations and Flicker Measurement.....	32
9.1. Standard.....	32
9.2. Test Procedure.....	32
9.3. Test Equipment Settings.....	32
9.4. Typical Test Setup Layout of Voltage Fluctuations and Flicker.....	32
9.5. Test Result of Voltage Fluctuation and Flicker.....	33
10. Electrostatic Discharge Immunity Measurement (ESD)	34
10.1. Test Setup.....	34
10.2. Test Setup for Tests Performed in Laboratory.....	35
10.3. ESD Test Procedure.....	36
10.4. Test Severity Levels.....	37
10.5. Test Points.....	38
11. Radio Frequency Electromagnetic Field Immunity Measurement (RS).....	39
11.1. Test Record.....	39
11.2. Test Setup.....	40
11.3. Test Procedure.....	40
11.4. Test Severity Levels.....	41
12. Electrical Fast Transient/Burst Immunity Measurement (EFT/BURST)	42
12.1. Test Record.....	42
12.2. Test setup.....	43
12.3. Test on Power Line.....	43
12.4. Test on Communication Lines.....	44
12.5. Test Procedure.....	44
12.6. Test Severity Levels.....	44
13. Surge Immunity Measurement	45
13.1. Test Record.....	46
13.2. Test Severity Levels.....	47
13.3. Test Procedure.....	47
13.4. Operating Condition.....	48
14. Conducted Disturbances Induced by Radio-Frequency Field Immunity Measurement (CS).....	49
14.1. Test Record.....	49
14.2. Test Severity Levels.....	49
14.3. Operating Condition.....	50
14.4. Test Procedure.....	50
15. Power Frequency Magnetic Field immunity Measurement (PFMF).....	51
15.1. Test Record.....	51
15.2. Test Setup.....	51
16. Voltage Dips and Voltage Interruptions Immunity Measurement (DIP)	52
16.1. Test Record of Voltage Interruption.....	52
16.2. Test Record of Voltage Dips.....	52
16.3. Testing Requirement and Procedure.....	53
16.4. Test Conditions.....	53
16.5. Operating Condition.....	53
17. Photographs of Test Configuration.....	54
17.1. Photographs of AC Powerline Conducted Emissions and Disturbances at Telecommunication ports Test Configuration.....	54
17.2. Photographs of Radiated Emissions Test Configuration.....	55



17.3. Photographs of Harmonic, Flicker, Surge, Dip Test Configuration57
17.4. Photographs of ESD Immunity Test Configuration58
17.5. Photographs of RS Immunity Test Configuration.....59
17.6. Photographs of EFT/BURST Immunity Test Configuration.....60
17.7. Photographs of CS Immunity Test Configuration.....62
17.8. Photographs of PFMF immunity test Configuration63
18. List of Measuring Equipment Used64
19. Uncertainty of Test Site67
20. Notice for Class A Product72
Appendix A. Photographs of EUT A1 ~ A12

CERTIFICATE OF COMPLIANCE

according to

**European Standard EN 55022:2010 Class A,
EN 61000-3-2:2006/A1:2009/A2:2009, EN 61000-3-3:2008 and
EN 55024:2010 (IEC 61000-4-2:2008,
IEC 61000-4-3:2006/A1:2007/A2:2010, IEC 61000-4-4:2004/A1:2010,
IEC 61000-4-5:2005, IEC 61000-4-6:2008,
IEC 61000-4-8:2009, IEC 61000-4-11:2004)**

Equipment : 20-Port 10/100/1000Base-T + 4 TP/(100/1G) SFP
Combo + 2 (100/1G) SFP L2 Plus Managed Switch

Model No. : VigorSwitch G2260, VigorSwitch P2261

Applicant : **DrayTek Corp.**
No. 26, Fushing Rd., Hukou, Hsinchu Industrial Park, Hsinchu,
303, Taiwan

I HEREBY CERTIFY THAT :

The measurements shown in this test report were made in accordance with the procedures given in **EUROPEAN COUNCIL DIRECTIVE 2004/108/EC**. The equipment was *passed* the test performed according to **European Standard EN 55022:2010 Class A, EN 61000-3-2:2006/A1:2009/A2:2009, EN 61000-3-3:2008 and EN 55024:2010 (IEC 61000-4-2:2008, IEC 61000-4-3:2006/A1:2007/A2:2010, IEC 61000-4-4:2004/A1:2010, IEC 61000-4-5:2005, IEC 61000-4-6:2008, IEC 61000-4-8:2009, IEC 61000-4-11:2004)**.

The test was carried out on Jun. 06, 2012 at **SPORTON International Inc.** LAB.

Reviewed by:

Approved by:



Jack Deng
Engineer Dept. Manager



Alex Chen
QA Dept. Director

SPORTON International Inc.

6F, No. 106, Sec. 1, Hsin Tai Wu Rd., Hsi Chih, Taipei Hsien, Taiwan, R.O.C.

1. General Description of Equipment under Test

1.1. Applicant

DrayTek Corp.

No. 26, Fushing Rd., Hukou, Hsinchu Industrial Park, Hsinchu, 303, Taiwan

1.2. Manufacturer

RUBY TECH CORP.

3F, NO. 1, LANE 50, NAN KANG ROAD, SEC. 3, TAIPEI, TAIWAN

1.3. Basic Description of Equipment under Test

Equipment : 20-Port 10/100/1000Base-T + 4 TP/(100/1G) SFP Combo + 2
(100/1G) SFP L2 Plus Managed Switch

Model No. : VigorSwitch G2260, VigorSwitch P2261

Trade Name : DrayTek

RJ45-RS232 Cable : Non-Shielded, 1.8 m

RJ45 Cable x2 : Non-Shielded, 20 m

Data Cable Type : Please see section 3.2 of this test report for details

Power Supply Type : From Switching Power Supply

AC Power Cord : Non-Shielded, 1.8 m, 3 pin

1.4. Feature of Equipment under Test

Please refer to user manual.

2. Summary of the Test Result

2.1. Emission Tests

Emissions			
Test Standard	Description of Test	Result	Remark
EN 55022:2010	AC Power Conducted Emissions	Complies	-
EN 55022:2010	Telecommunication Ports Conducted	Complies	-
EN 55022:2010	Radiated Emissions (Below 1GHz)	Complies	-
	Radiated Emissions (Above 1GHz)	Complies	-
EN 61000-3-2:2006/A1:2009/A2:2009	Harmonic Current Emissions	Complies	-
EN 61000-3-3:2008	Voltage Fluctuations and Flicker	Complies	-

2.2. Immunity Tests

Applicable Standard : EN 55024:2010			
Test Standard	Description of Test	Result	Criteria
IEC 61000-4-2:2008	ESD (EUT of Enclosure)	Complies	B
IEC 61000-4-3:2006/A1:2007/A2:2010	RS (EUT of Enclosure)	Complies	A
IEC 61000-4-4:2004/A1:2010	EFT (EUT of AC Power Port)	Complies	B
IEC 61000-4-4:2004/A1:2010	EFT (EUT of signal ports and telecommunication ports)	Complies	A
IEC 61000-4-5:2005	Surge (EUT of AC Power Port)	Complies	A
IEC 61000-4-5:2005	Surge (EUT of signal ports and telecommunication ports)	Complies	B
IEC 61000-4-6:2008	CS (EUT of AC Power Port)	Complies	A
IEC 61000-4-6:2008	CS (EUT of signal ports and telecommunication ports)	Complies	A
IEC 61000-4-8:2009	PFMF (EUT of Enclosure)	Complies	A
IEC 61000-4-11:2004	DIP (EUT of AC Power Port)	Complies	C/C/A

3. Test Configuration of Equipment under Test

3.1. Test Manner

- a. The EUT has been associated with personal computer and peripherals pursuant to European Standard EN 55022 and EN 55024.
- b. The equipment under test were performed the following test modes:

Test Items	Description of test modes
AC Conducted Emission	Mode 1. FIBER + LAN 1Gbps Mode 2. RJ-45 + LAN 1Gbps Mode 3. RJ-45 + LAN 1Gbps Cause "mode 3" generated the worst test result; it was reported as final data.
ISN	Mode 1. LAN: 10Mbps Mode 2. LAN: 100Mbps Mode 3. LAN: 1Gbps Mode 4. LAN: 10Mbps Mode 5. LAN: 100Mbps Mode 6. LAN: 1Gbps Cause "mode 1-3" generated the worst test result; it was reported as final data.
Radiated Emissions	Mode 1. FIBER + LAN 1Gbps Mode 2. RJ-45 + LAN 1Gbps Mode 3. RJ-45 + LAN 1Gbps < below 1GHz > Cause "mode 3" generated the worst test result; it was reported as final data. Mode 1. FIBER + LAN 1Gbps Mode 2. FIBER + LAN 1Gbps < above 1GHz > Cause "mode 2" is highest frequency of the internal sources of the EUT; it was reported as final data.
Harmonic and Flicker Emissions	Mode 1. LAN 1Gbps x2
EMS	Mode 1. LAN 1Gbps x2

- c. Frequency range investigated: Conduction 150 kHz to 30 MHz, Radiation 30 MHz to 6,000 MHz.
- d. Frequency range investigated immunity test: CS 150 kHz to 80 MHz, RS 80 MHz to 1,000 MHz.

3.2. Description of Test System

< EMI ><Conducted and Radiated below 1GHz>

No.	Peripheral	Manufacturer	Model Number	FCC ID	Cable / Spec. Description	Placed
1	PD JIG	RUBY TECH	N/A	N/A	RJ45 Cable x24, Non-Shielded, 2.0m	Local
2	FIBER Module x4	RUBY TECH	Mulit	N/A	FIBER Cable x4, Non-Shielded, 2.1m	Local
3	FIBER Module x2	RUBY TECH	Mulit	N/A	FIBER Cable, Non-Shielded, 2.1m	Local
4	Personal Computer x2	DELL	DCTA	DoC	N/A	Remote
5	LCD Monitor x2	DELL	E198WFPf	DoC	D-SUB Cable, D-Shielded, 1.8m	Remote
6	USB Keyboard x2	DELL	SK-8175	DoC	USB Cable, AL-F-Shielded, 1.8m	Remote
7	USB Mouse x2	DELL	MOC5UO	DoC	USB Cable, AL-F-Shielded, 1.8m	Remote

< EMI ><Radiated above 1GHz>

No.	Peripheral	Manufacturer	Model Number	FCC ID	Cable / Spec. Description	Placed
1	PD JIG	RUBY TECH	N/A	N/A	RJ45 Cable, Non-Shielded, 2.0m	Local
2	FIBER Module x6	RUBY TECH	Mulit	N/A	FIBER Cable x3, Non-Shielded, 2.1m	Local
3	Notebook PC x2	DELL	E5520	DoC	N/A	Remote

< EMS >

No.	Peripheral	Manufacturer	Model Number	FCC ID	Cable / Spec. Description	Placed
1	PD JIG	RUBY TECH	N/A	N/A	RJ45 Cable x24, Non-Shielded, 2.0m	Local
2	FIBER Module x6	RUBY TECH	Mulit	N/A	FIBER Cable x6, Non-Shielded, 2.1m	Local
3	Personal Computer x2	DELL	470	DoC	N/A	Remote
4	LCD Monitor x2	DELL	E198WFPf	DoC	D-SUB Cable, Shielded, 1.8m	Remote
5	USB Keyboard x2	DELL	SK-8115	DoC	USB Cable, AL-F-Shielded, 2.0m	Remote
6	USB Mouse x2	DELL	MOA8BO	DoC	USB Cable, AL-F-Shielded, 1.8m	Remote

4. Test Software

< EMI >

During the test, the program under Win XP from remote workstation was executed:

- Executed "ping.exe" to link with the EUT to receive and transmit data by RJ45 cable.

For ISN test, the remote workstation executed "tfggen.exe" to traffic packet data generated software and keep 10% traffic load to link with the EUT by RJ45 cable.

< EMS >

During the test, the program under Win XP from remote workstation was executed:

- Executed "ping.exe" to link with the EUT to receive and transmit data by RJ45 cable.

5. General Information of Test

5.1. Test Facility

<EMI>

Test Site : SPORTON INTERNATIONAL INC.

Test Site Location : No. 3, Lane 238, Kang Lo Street, Nei Hwu District, Taipei 11424, Taiwan, R.O.C.

TEL : 886-2-2631-4739

FAX : 886-2-2631-9740

Test Site No. : CO01-NH, OS02-NH

Test Site Location : No. 52, Hwa Ya 1st Rd., Hwa Ya Technology Park, Kwei-Shan Hsiag, Tao Yuan Hsien, Taiwan, R.O.C.

TEL : 886-3-327-3456

FAX : 886-3-318-0055

Test Site No. : 03CH03-HY

<EMS>

Test Site Location : 3F, No.587, Tanmeu St., Neihu District, Taipei, Taiwan, R.O.C.

TEL : 886-2-2794-8886

FAX : 886-2-2794-9777

5.2. Test Voltage

AC 230V / 50Hz

5.3. Measurement Procedure

EMI Test : European Standard EN 55022 Class A

Harmonics Test : European Standard EN 61000-3-2

Voltage Fluctuations Test : European Standard EN 61000-3-3

EMS Test : European Standard EN 55024

(ESD: IEC 61000-4-2, RS: IEC 61000-4-3, EFT: IEC 61000-4-4, SURGE: IEC 61000-4-5,

CS: IEC 61000-4-6, Power Frequency Magnetic Field: IEC 61000-4-8, DIPS: IEC 61000-4-11)

5.4. Test in Compliance with

EMI Test : European Standard EN 55022 Class A

Harmonics Test : European Standard EN 61000-3-2

Voltage Fluctuations Test : European Standard EN 61000-3-3

EMS Test : European Standard EN 55024

(ESD: IEC 61000-4-2, RS: IEC 61000-4-3, EFT: IEC 61000-4-4, SURGE: IEC 61000-4-5,

CS: IEC 61000-4-6, Power Frequency Magnetic Field: IEC 61000-4-8, DIPS: IEC 61000-4-11)

5.5. Frequency Range Investigated

- a. Conducted emission test: from 150 kHz to 30 MHz
- b. Radiated emission test: from 30 MHz to 6,000 MHz
- c. Radio frequency electromagnetic field immunity test: 80-1000 MHz

5.6. Test Distance

- a. The test distance of radiated emission test from antenna to EUT is 10 M (from 30MHz~1GHz).
- b. The test distance of radiated emission test from antenna to EUT is 3 M (from 1GHz~6GHz).
- c. The test distance of radio frequency electromagnetic field immunity test from antenna to EUT is 3 M.

6. Conducted Emissions Measurement

Conducted Emissions were measured from 150 kHz to 30 MHz with a bandwidth of 9 kHz and return leads of the EUT according to the methods defined in European Standard EN 55022 Clause 9. The EUT was placed on a nonmetallic stand in a shielded room 0.8 meter above the ground plane as shown in section 6.4. The interface cables and equipment positioning were varied within limits of reasonable applications to determine the position producing maximum conducted emissions.

6.1. Limits for conducted disturbance at mains terminals and telecommunication ports

Limits for conducted disturbance at mains terminals

Frequency range (MHz)	Class A Limits dB(μV)		Class B Limits dB(μV)	
	Quasi-peak	Average	Quasi-peak	Average
0.15 to 0.50	79	66	66 - 56	56 - 46
0.50 to 5	73	60	56	46
5 to 30	73	60	60	50

NOTE: The limits decrease linearly with the logarithm of the frequency in the range 0.15 MHz to 0.5 MHz.

Limits for conducted disturbance at telecommunication ports

Frequency range (MHz)	Class A			
	Voltage limits dB (μV)		Current limits dB (μA)	
	Quasi-peak	Average	Quasi-peak	Average
0.15 to 0.50	97 - 87	84 - 74	53 - 43	40 - 30
0.50 to 30	87	74	43	30

NOTE: The limits decrease linearly with the logarithm of the frequency in the range 0.15 MHz to 0.5 MHz.

Frequency range (MHz)	Class B			
	Voltage limits dB (μV)		Current limits dB (μA)	
	Quasi-peak	Average	Quasi-peak	Average
0.15 to 0.50	84 - 74	74 - 64	40 - 30	30 - 20
0.50 to 30	74	64	30	20

NOTE: The limits decrease linearly with the logarithm of the frequency in the range 0.15 MHz to 0.5 MHz.



6.2. Description of Major Test Instruments

Test Receiver Parameters	Setting
Test Receiver	R&S ESCS 30
Attenuation	10 dB
Start Frequency	0.15 MHz
Stop Frequency	30 MHz
IF Bandwidth	9 kHz
Signal Input	9 kHz - 2.75 GHz

6.3. Test Procedures

- a. The EUT was placed on a desk 0.8 meter height from the metal ground plane and 0.4 meter from the conducting wall of the shielding room and it was kept at least 0.8 meter from any other grounded conducting surface.
- b. Connect EUT to the power mains through a line impedance stabilization network (LISN).
- c. Connect Telecommunication port to ISN (Impedance Stabilization Network).
- d. All the support units are connect to the other LISN.
- e. The LISN provides 50 ohm, coupling impedance for the measuring instrument.
- f. The CISPR states that a 50 ohm, 50 microhenry LISN should be used.
- g. Both sides of AC line were checked for maximum conducted interference.
- h. The frequency range from 150 kHz to 30 MHz was searched.
- i. Set the test-receiver system to Peak Detect Function and Specified Bandwidth with Maximum Hold Mode.

6.4. Typical Test Setup Layout of AC Powerline Conducted Emissions

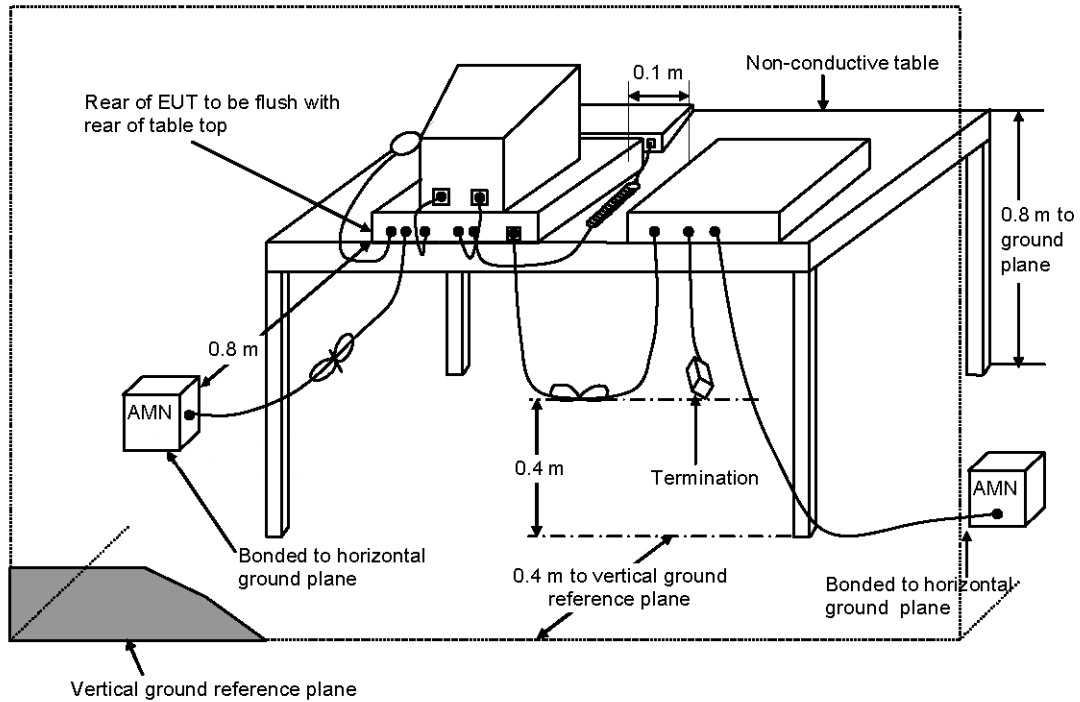

- a. AMN is 80 cm from the EUT and at least 80 cm from other units and other metal planes.
- b. EUT is connected to one artificial mains network (AMN).
- c. All other units of a system are powered from a second AMN. A multiple outlet strip can be used for multiple mains cords.
- d. Rear of EUT to be flushed with rear of table top.
- e. Peripherals shall be placed at a distance of 10 cm from each other and from the controller, except for the monitor which, if this is an acceptable installation practice, shall be placed directly on the top of the controller.
- f. If cables, which hang closer than 40 cm to the horizontal metal ground plane, cannot be shortened to appropriate length, the excess shall be folded back and forth forming a bundle 30 cm to 40 cm long.
- g. Mains cords and signal cables shall be positioned for their entire lengths, as far as possible, at 40 cm from the vertical reference plane.
- h. Cables of hand operated devices, such as keyboards, mice, etc. shall be placed as for normal usage.

6.5. Typical Test Setup Layout of Disturbance at Telecommunication Ports

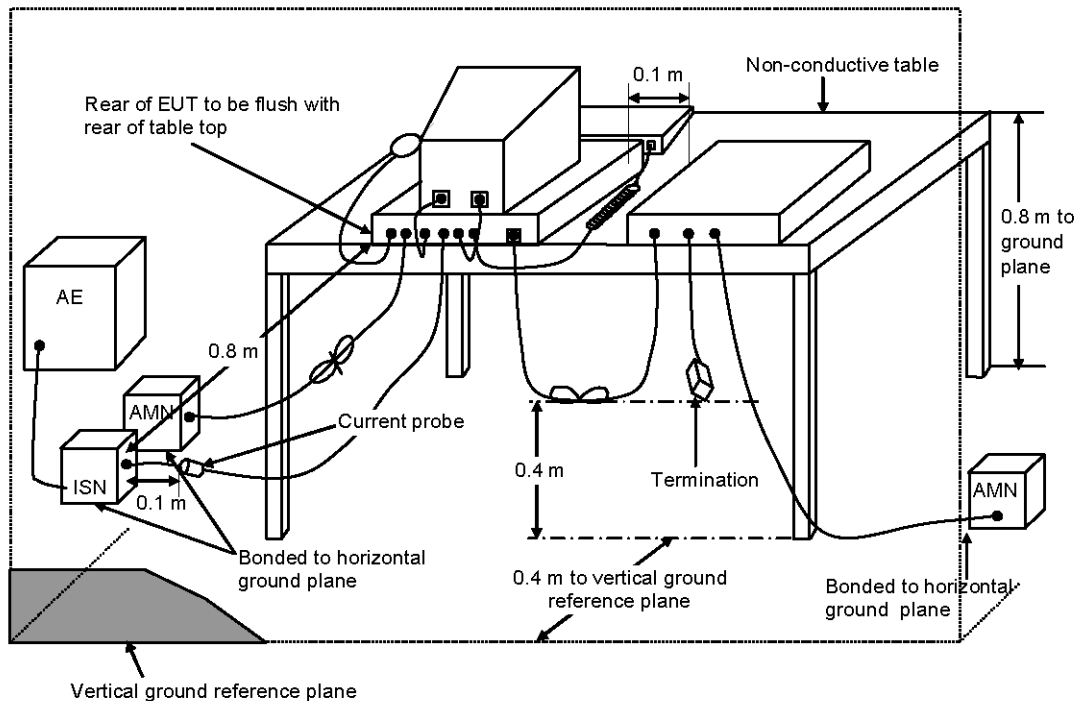

- AMN and ISN are 80 cm from the EUT and at least 80 cm from other units and other metal planes.
- EUT is connected to one artificial mains network (AMN).
- All other units of a system are powered from a second AMN. A multiple outlet strip can be used for multiple mains cords.
- Rear of EUT to be flushed with rear of table top.
- Peripherals shall be placed at a distance of 10 cm from each other and from the controller, except for the monitor which, if this is an acceptable installation practice, shall be placed directly on the top of the controller.
- If cables, which hang closer than 40 cm to the horizontal metal ground plane, cannot be shortened to appropriate length, the excess shall be folded back and forth forming a bundle 30 cm to 40 cm long.
- Mains cords and signal cables shall be positioned for their entire lengths, as far as possible, at 40 cm from the vertical reference plane.
- Cables of hand operated devices, such as keyboards, mice, etc. shall be placed as for normal usage.

6.6. Test Result of AC Powerline Conducted Emission

Test Mode	Mode 3	Test Site No.	CO01-NH
Test Frequency	0.15 MHz ~ 30 MHz	Test Engineer	Eddie
Temperature	23 °C	Relative Humidity	54 %

Note: 1. Corrected Reading (dBµV) = LISN Factor + Cable Loss + Read Level = Level
 2. All emissions not reported here are more than 10 dB below the prescribed limit.

■ The test was passed at the minimum margin that marked by the frame in the following data

Line

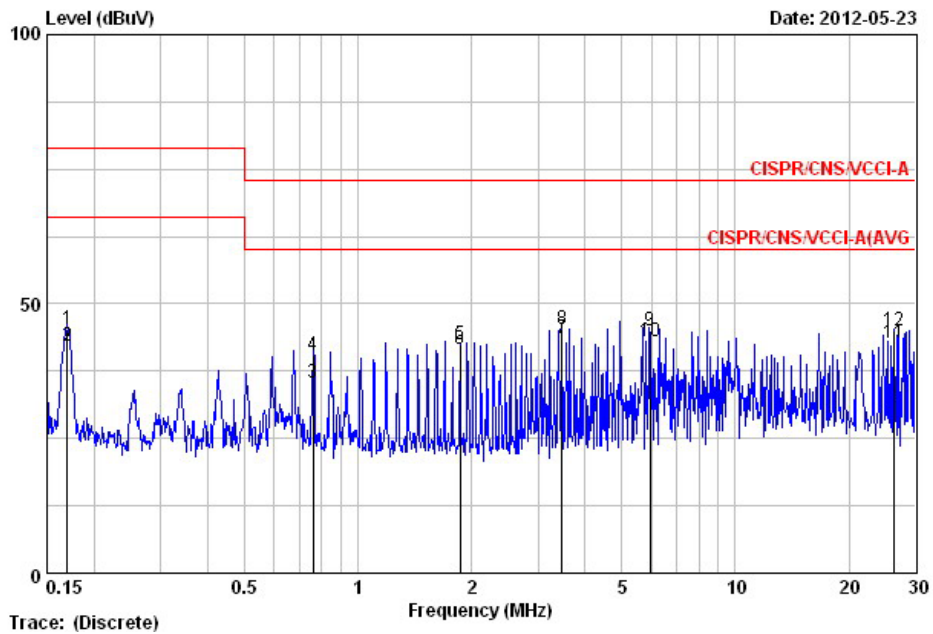

	Freq	Level	Over Limit	Limit Line	Read Level	LISN Factor	Cable Loss	Remark
	MHz	dBuV	dB	dBuV	dBuV	dB	dB	
1	0.169	45.23	-33.77	79.00	34.97	10.15	0.10	QP
2	0.169	42.30	-23.70	66.00	32.04	10.15	0.10	AVERAGE
3	0.760	35.23	-24.77	60.00	24.96	10.17	0.10	AVERAGE
4	0.760	40.45	-32.55	73.00	30.18	10.17	0.10	QP
5	1.865	42.39	-30.61	73.00	32.10	10.19	0.10	QP
6	1.865	41.64	-18.36	60.00	31.35	10.19	0.10	AVERAGE
7	3.475	43.65	-16.35	60.00	33.27	10.20	0.18	AVERAGE
8	3.475	45.39	-27.61	73.00	35.01	10.20	0.18	QP
9	5.932	45.05	-27.95	73.00	34.61	10.24	0.20	QP
10	5.932	42.96	-17.04	60.00	32.52	10.24	0.20	AVERAGE
11	26.271	42.73	-17.27	60.00	31.87	10.53	0.33	AVERAGE
12	26.271	45.06	-27.94	73.00	34.20	10.53	0.33	QP

Neutral

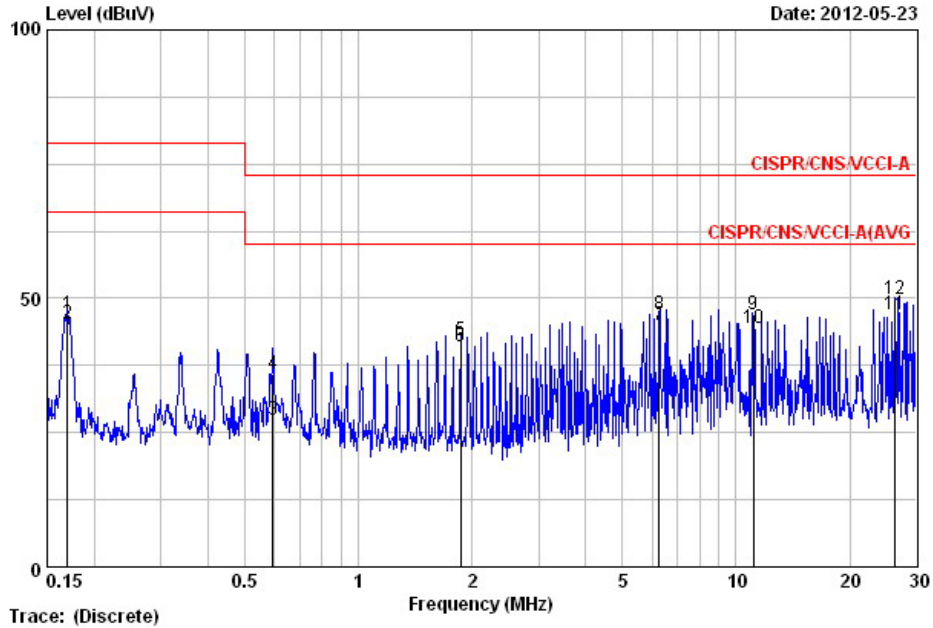

	Freq	Level	Over Limit	Limit Line	Read Level	LISN Factor	Cable Loss	Remark
	MHz	dBuV	dB	dBuV	dBuV	dB	dB	
1	0.169	47.05	-31.95	79.00	36.81	10.14	0.10	QP
2	0.169	45.37	-20.63	66.00	35.13	10.14	0.10	AVERAGE
3	0.595	27.45	-32.55	60.00	17.20	10.14	0.10	AVERAGE
4	0.595	35.94	-37.06	73.00	25.69	10.14	0.10	QP
5	1.862	42.06	-30.94	73.00	31.79	10.17	0.10	QP
6	1.862	40.91	-19.09	60.00	30.64	10.17	0.10	AVERAGE
7	6.266	44.91	-15.09	60.00	34.48	10.23	0.20	AVERAGE
8	6.266	47.03	-25.97	73.00	36.60	10.23	0.20	QP
9	11.093	46.90	-26.10	73.00	36.39	10.31	0.20	QP
10	11.093	44.48	-15.52	60.00	33.97	10.31	0.20	AVERAGE
11	26.253	46.87	-13.13	60.00	35.95	10.60	0.33	AVERAGE
12	26.253	49.92	-23.08	73.00	39.00	10.60	0.33	QP

6.7. Test Result of Disturbance at Telecommunication Ports

Test Mode	Mode 1	Test Site No.	CO01-NH
Test Frequency	0.15 MHz ~ 30 MHz	Test Engineer	Eddie
Temperature	23 °C	Relative Humidity	54 %

Note: 1. Corrected Reading (dBμV) = LISN Factor + Cable Loss + Read Level = Level
 2. All emissions not reported here are more than 10 dB below the prescribed limit.

■ The test was passed at the minimum margin that marked by the frame in the following data

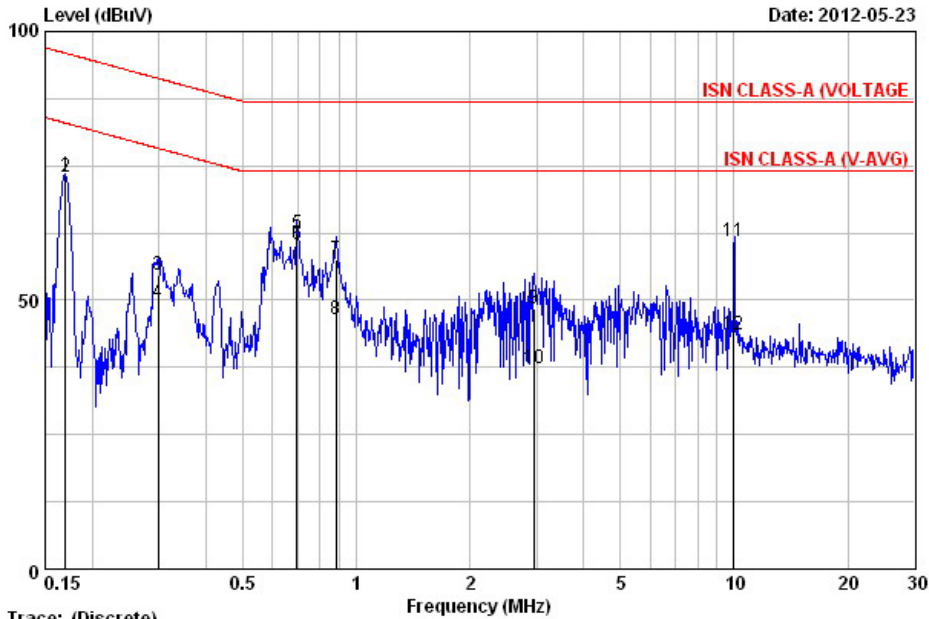

Trace: (Discrete)
 Site : CO01-NH
 Condition : ISN CLASS-A (VOLTAGE T800-20110919)
 eut :
 power : AC 230V
 memo : LAN 1
 : LAN 10Mbps-10%

	Freq	Level	Over	Limit	Read	LISN	Cable	
	MHz	dBuV	Limit	Line	Level	Factor	Loss	Remark
			dB	dBuV	dBuV	dB	dB	
1	0.169	73.19	-22.79	95.99	62.93	10.16	0.10	QP
2	0.169	73.05	-9.93	82.99	62.79	10.16	0.10	AVERAGE
3	0.299	54.81	-36.47	91.28	44.74	9.96	0.10	QP
4	0.299	49.53	-28.75	78.28	39.46	9.96	0.10	AVERAGE
5	0.697	62.29	-24.71	87.00	52.40	9.79	0.10	QP
6	0.697	60.30	-13.70	74.00	50.41	9.79	0.10	AVERAGE
7	0.885	57.59	-29.41	87.00	47.73	9.76	0.10	QP
8	0.885	46.41	-27.59	74.00	36.55	9.76	0.10	AVERAGE
9	2.948	48.35	-38.65	87.00	38.52	9.67	0.16	QP
10	2.948	37.25	-36.75	74.00	27.42	9.67	0.16	AVERAGE
11	10.000	60.99	-26.01	87.00	51.14	9.65	0.20	QP
12	10.000	43.67	-30.33	74.00	33.82	9.65	0.20	AVERAGE

Test Mode	Mode 2	Test Site No.	CO01-NH
Test Frequency	0.15 MHz ~ 30 MHz	Test Engineer	Eddie
Temperature	23 °C	Relative Humidity	54 %

Note: 1. Corrected Reading (dBμV) = LISN Factor + Cable Loss + Read Level = Level
 2. All emissions not reported here are more than 10 dB below the prescribed limit.

■ The test was passed at the minimum margin that marked by the frame in the following data

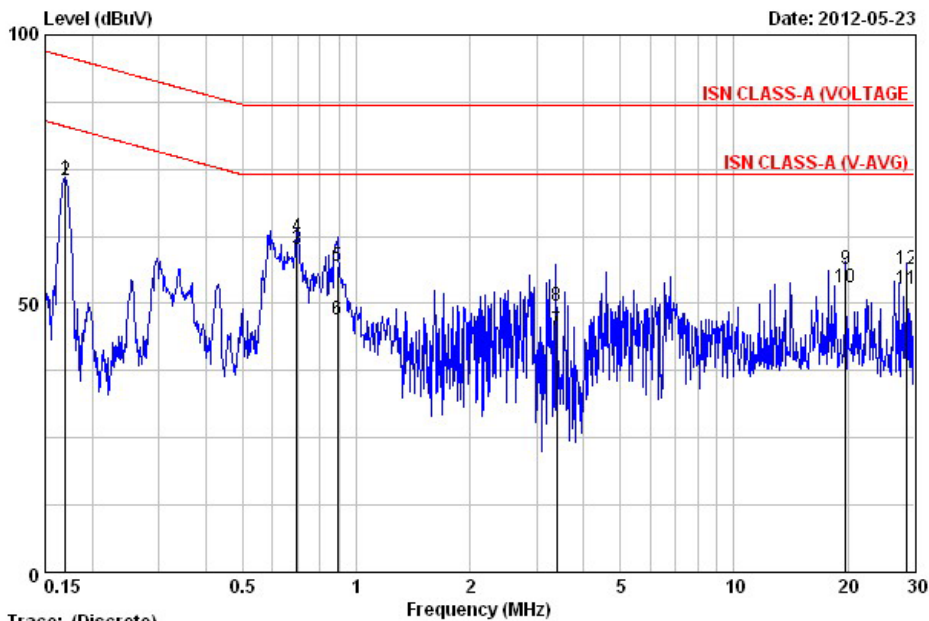

Trace: (Discrete)
 Site : CO01-NH
 Condition : ISN CLASS-A (VOLTAGE T800-20110919)
 eut :
 power : AC 230V
 memo : LAN 1
 : LAN 100Mbps-10%

	Freq	Level	Over Limit	Limit Line	Read Level	LISN Factor	Cable Loss	Remark
	MHz	dBuV	dB	dBuV	dBuV	dB	dB	
1	0.169	73.09	-22.89	95.99	62.83	10.16	0.10	QP
2	0.169	73.00	-9.98	82.99	62.74	10.16	0.10	AVERAGE
3	0.697	60.25	-13.75	74.00	50.36	9.79	0.10	AVERAGE
4	0.697	62.37	-24.63	87.00	52.48	9.79	0.10	QP
5	0.890	57.04	-29.96	87.00	47.18	9.76	0.10	QP
6	0.890	46.87	-27.13	74.00	37.01	9.76	0.10	AVERAGE
7	3.387	45.11	-28.89	74.00	35.27	9.66	0.18	AVERAGE
8	3.387	49.55	-37.45	87.00	39.71	9.66	0.18	QP
9	19.710	56.35	-30.65	87.00	46.25	9.81	0.29	QP
10	19.710	52.96	-21.04	74.00	42.86	9.81	0.29	AVERAGE
11	28.684	52.61	-21.39	74.00	42.06	10.17	0.38	AVERAGE
12	28.684	56.33	-30.67	87.00	45.78	10.17	0.38	QP

Test Mode	Mode 3	Test Site No.	CO01-NH
Test Frequency	0.15 MHz ~ 30 MHz	Test Engineer	Eddie
Temperature	23 °C	Relative Humidity	54 %

Note: 1. Corrected Reading (dBμV) = LISN Factor + Cable Loss + Read Level = Level
 2. All emissions not reported here are more than 10 dB below the prescribed limit.

■ The test was passed at the minimum margin that marked by the frame in the following data

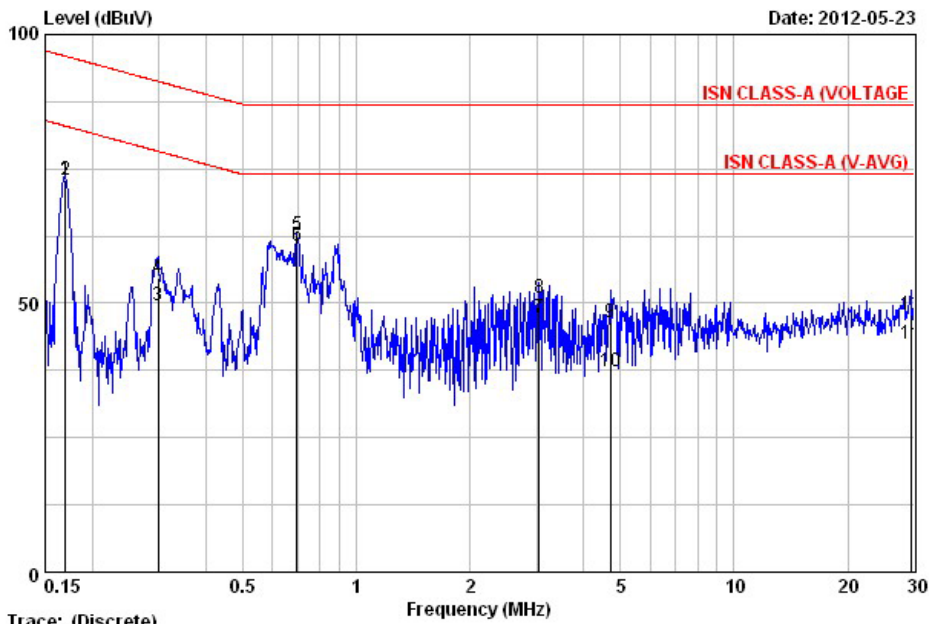

Trace: (Discrete)
 Site : CO01-NH
 Condition : ISN CLASS-A (VOLTAGE T800-20110919)
 eut :
 power : AC 230V
 memo : LAN 1
 : LAN 1Gbps-10%

	Freq	Level	Over Limit	Limit Line	Read Level	LISN Factor	Cable Loss	Remark
	MHz	dBuV	dB	dBuV	dBuV	dB	dB	
1	0.169	73.03	-22.95	95.99	62.77	10.16	0.10	QP
2	0.169	72.95	-10.03	82.99	62.69	10.16	0.10	AVERAGE
3	0.299	49.48	-28.80	78.28	39.41	9.96	0.10	AVERAGE
4	0.299	54.74	-36.54	91.28	44.67	9.96	0.10	QP
5	0.697	62.67	-24.33	87.00	52.78	9.79	0.10	QP
6	0.697	60.56	-13.44	74.00	50.67	9.79	0.10	AVERAGE
7	3.041	47.29	-26.71	74.00	37.46	9.67	0.16	AVERAGE
8	3.041	51.05	-35.95	87.00	41.22	9.67	0.16	QP
9	4.696	46.57	-40.43	87.00	36.73	9.64	0.20	QP
10	4.696	37.43	-36.57	74.00	27.59	9.64	0.20	AVERAGE
11	29.371	42.35	-31.65	74.00	31.77	10.20	0.39	AVERAGE
12	29.371	47.86	-39.14	87.00	37.28	10.20	0.39	QP

7. Radiated Emission Measurement

Radiated emissions from 30 MHz to 6,000 MHz were measured with a bandwidth of 120 kHz for 30 MHz to 1,000 MHz and 1 MHz for above 1GHz according to the methods defines in European Standard EN 55022, Clause 10. The EUT was placed on a nonmetallic stand, 0.8 meter above the ground plane, as shown in section 7.4. The interface cables and equipment positions were varied within limits of reasonable applications to determine the positions producing maximum radiated emissions.

7.1. Limits for radiated disturbance

Limits for radiated disturbance at a measuring distance of 10 m

Frequency range (MHz)	Class A	Class B
	Quasi-peak limits dB(μV/m)	Quasi-peak limits dB(μV/m)
30 to 230	40	30
230 to 1000	47	37

Limits for radiated disturbance at a measuring distance of 3 m

Frequency range (MHz)	Class A		Class B	
	Average limit dB(μV/m)	Peak limit dB(μV/m)	Average limit dB(μV/m)	Peak limit dB(μV/m)
1000 to 3000	56	76	50	70
3000 to 6000	60	80	54	74

7.2. Description of Major Test Instruments

For Below 1GHz

Amplifier Parameters	Setting
Amplifier	BURGEON BPA-530
RF Gain	30 dB
Signal Input	0.01 MHz - 3 GHz

Test Receiver Parameters	Setting
Test Receiver	R&S ESCI
Resolution Bandwidth	120 kHz
Frequency Band	9 kHz - 3 GHz
Quasi-Peak Detector	ON for Quasi-Peak Mode OFF for Peak Mode

For above 1GHz

Amplifier Parameters	Setting
Amplifier	Agilent 8449B
RF Gain	35 dB
Signal Input	1 GHz - 26.5 GHz

Test Receiver Parameters	Setting
Test Receiver	R&S ESI
Attenuation	10 dB
Start Frequency	1000 MHz
Stop Frequency	6000 MHz
Resolution Bandwidth	1 MHz
Signal Input	20 Hz - 7 GHz

7.3. Test Procedures

For Below 1GHz

- a. The EUT was placed on a rotatable table top 0.8 meter above ground.
- b. The EUT was set 10 meters from the interference-receiving antenna which was mounted on the top of a variable height antenna tower.
- c. The table was rotated 360 degrees to determine the position of the highest radiation.
- d. The antenna is a half wave dipole and its height is varied between one meter and four meters above ground to find the maximum value of the field strength both horizontal polarization and vertical polarization of the antenna are set to make the measurement.
- e. For each suspected emission the EUT was arranged to its worst case and then tune the antenna tower (from 1 M to 4 M) and turn table (from 0 degree to 360 degrees) to find the maximum reading.
- f. Set the test-receiver system to Peak Detect Function and specified bandwidth with Maximum Hold Mode.
- g. If the emission level of the EUT in peak mode was 3 dB lower than the limit specified, then testing will be stopped and peak values of EUT will be reported, otherwise, the emissions which do not have 3 dB margin will be repeated one by one using the quasi-peak method and reported.

For above 1GHz

- a. Same test set up as below 1GHz radiated testing.
- b. The EUT was set 3 meters from the interference-receiving antenna which was mounted on the top of a variable height antenna tower.
- c. There should be absorber placed between the EUT and Antenna and its located size should let the test site meet CISPR16-1-4 requirement.
- d. The table was rotated 360 degrees to determine the position of the highest radiation.
- e. Set the test-receiver system to Peak Detect Function and specified bandwidth with Maximum Hold Mode.
- f. Set the DRG Horn Antenna (Model: 3115) at 1M height, then run the turn table to get the maximum noise reading from Horizontal and Vertical polarity separately.
- g. When EUT locating on the turn-table, and its height is over 172cm (Antenna's 3dB beam width of 6GHz is 27°), the DRG Horn Antenna must be raised up and descended down, then turning around the turn-table to get the maximum noise reading of the Horizontal and Vertical polarity separately. Note the maximum raise up height is same as the top of EUT.
- h. If emission level of the EUT in peak mode was 20dB lower than average limit (that means the emission level in peak mode also complies with the limit in average mode), then testing will be stopped and peak values of EUT will be reported, otherwise, the emissions will be measured in average mode again and reported.

7.4. Typical Test Setup Layout of Radiated Emissions

For Below 1GHz

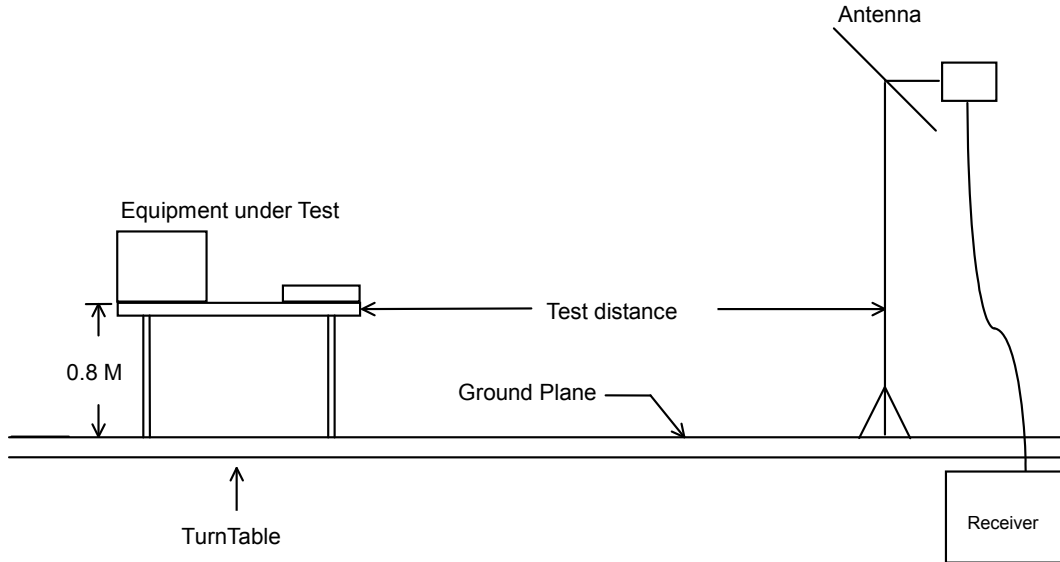

For above 1GHz

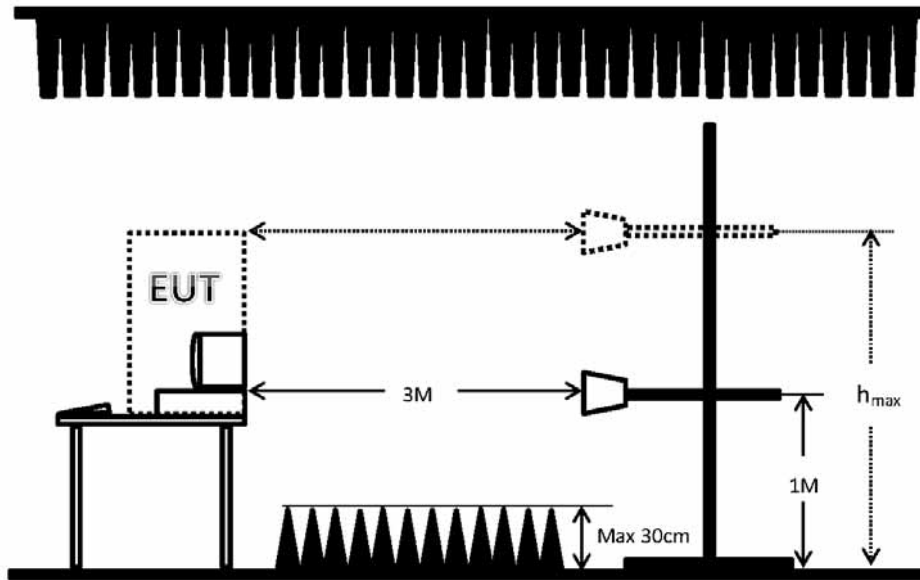

Remark: When EUT's height is over 172cm, h_{max} = top of EUT

7.5. Test Result of Radiated Emission for Below 1GHz

Test mode	Mode 3	Test Site No.	OS02-NH
Test frequency	30 MHz ~ 1000 MHz	Test Engineer	Chas
Temperature	28 °C	Relative Humidity	50 %

Note: 1. Emission level (dB μ V/m) = 20 log Emission level (μ V/m)

2. Corrected Reading : Antenna Factor + Cable Loss + Read Level – Preamp Factor = Level

■ The test was passed at the minimum margin that marked by the frame in the following data

Vertical

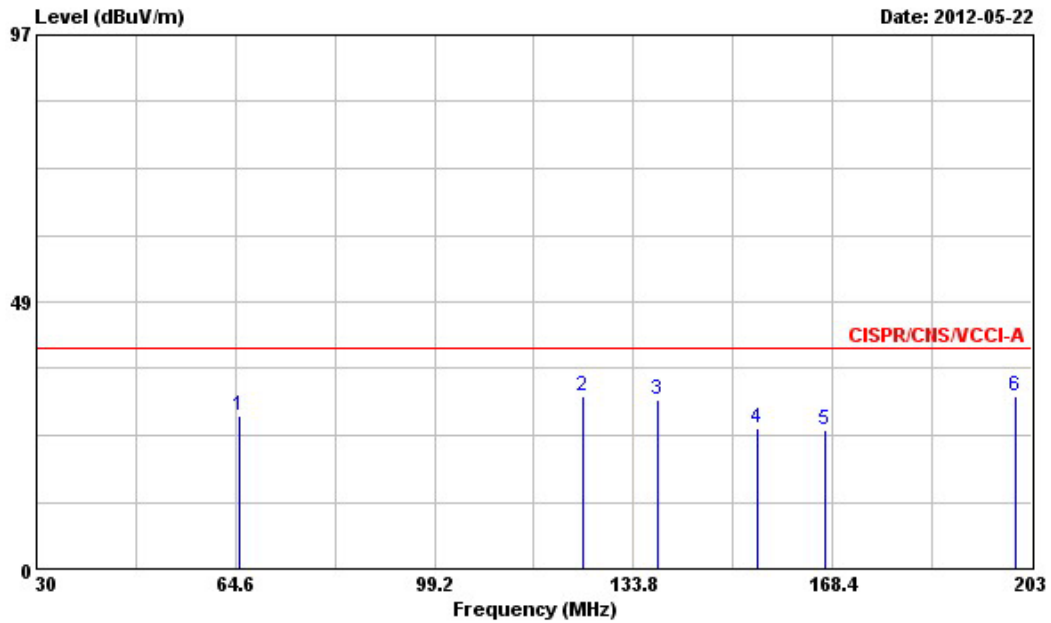

Freq	Level	Over Limit	Limit Line	Read Level	Antenna Factor	Cable Loss	Preamp Factor	Remark	Ant Pos	Table Pos
MHz	dBuV/m	dB	dBuV/m	dBuV	dB/m	dB	dB		cm	deg
1	65.290	27.83	-12.17	40.00	51.80	6.39	1.45	31.81 Peak	---	---
2	125.150	31.42	-8.58	40.00	48.78	12.36	1.92	31.64 Peak	100	360
3	137.950	30.87	-9.13	40.00	49.42	11.06	2.00	31.61 Peak	---	---
4	155.430	25.46	-14.54	40.00	44.62	10.26	2.15	31.57 Peak	---	---
5	167.020	25.17	-14.83	40.00	44.71	9.77	2.23	31.54 Peak	---	---
6	200.060	31.22	-8.78	40.00	50.84	9.32	2.52	31.46 Peak	---	---

Vertical

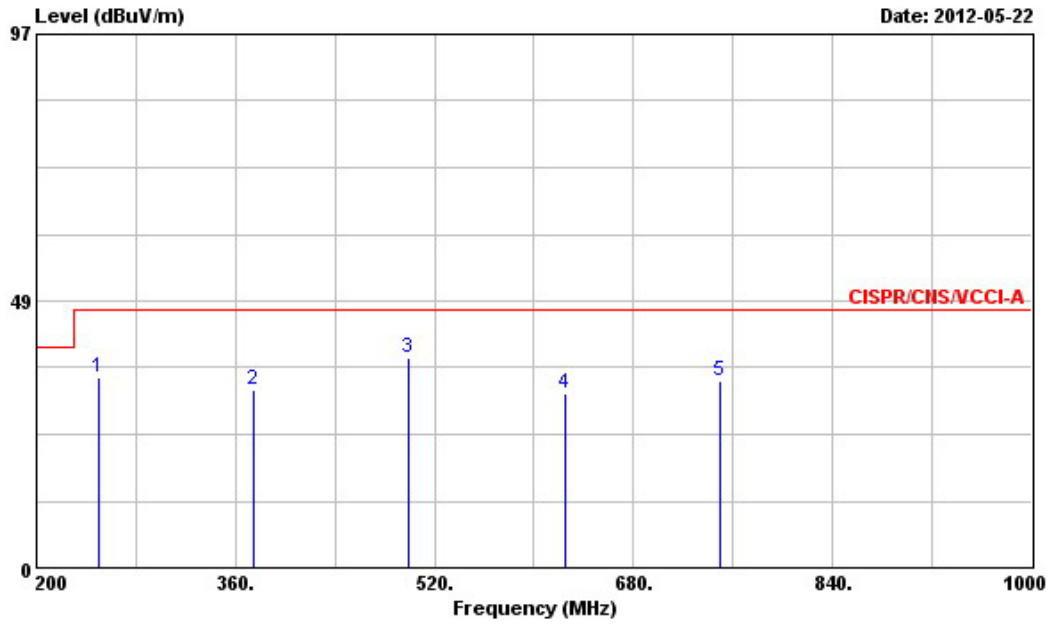

	Freq	Level	Over Limit	Limit Line	ReadAntenna Level	Antenna Factor	Cable Loss	Preamp Factor	Remark	Ant Pos	Table Pos
	MHz	dBuV/m	dB	dBuV/m	dBuV	dB/m	dB	dB		cm	deg
1	249.600	34.68	-12.32	47.00	50.93	12.29	2.88	31.42	Peak	---	---
2	374.400	32.23	-14.77	47.00	44.66	15.14	3.84	31.41	Peak	---	---
3	499.200	38.08	-8.92	47.00	47.14	17.55	4.74	31.35	Peak	---	---
4	624.800	31.77	-15.23	47.00	38.24	19.15	5.67	31.29	Peak	---	---
5	749.600	33.87	-13.13	47.00	38.49	19.98	6.71	31.31	Peak	---	---

Horizontal

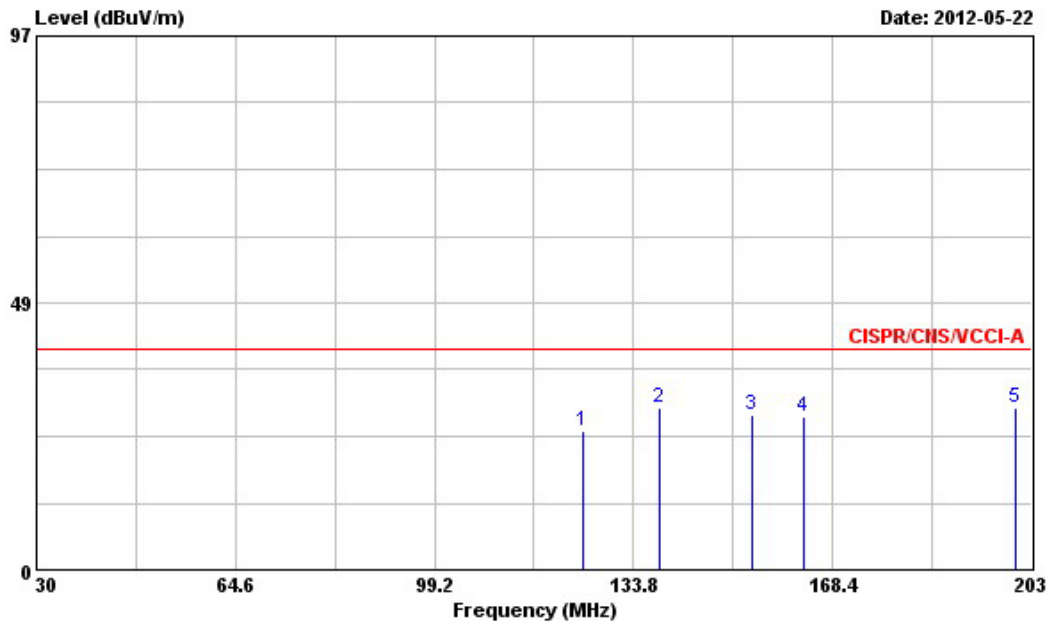

Freq	Level	Over Limit	Limit Line	ReadAntenna Level	Antenna Factor	Cable Loss	Preamp Factor	Remark	Ant Pos	Table Pos
MHz	dBuV/m	dB	dBuV/m	dBuV	dB/m	dB	dB		cm	deg
1	124.980	25.13	-14.87	40.00	42.49	12.36	1.92	31.64 Peak	---	---
2	138.300	29.44	-10.56	40.00	48.09	10.96	2.00	31.61 Peak	---	---
3	154.390	28.29	-11.71	40.00	47.45	10.27	2.15	31.58 Peak	---	---
4	163.380	27.89	-12.11	40.00	47.30	9.95	2.20	31.56 Peak	---	---
5	200.060	29.34	-10.66	40.00	48.96	9.32	2.52	31.46 Peak	---	---

Horizontal

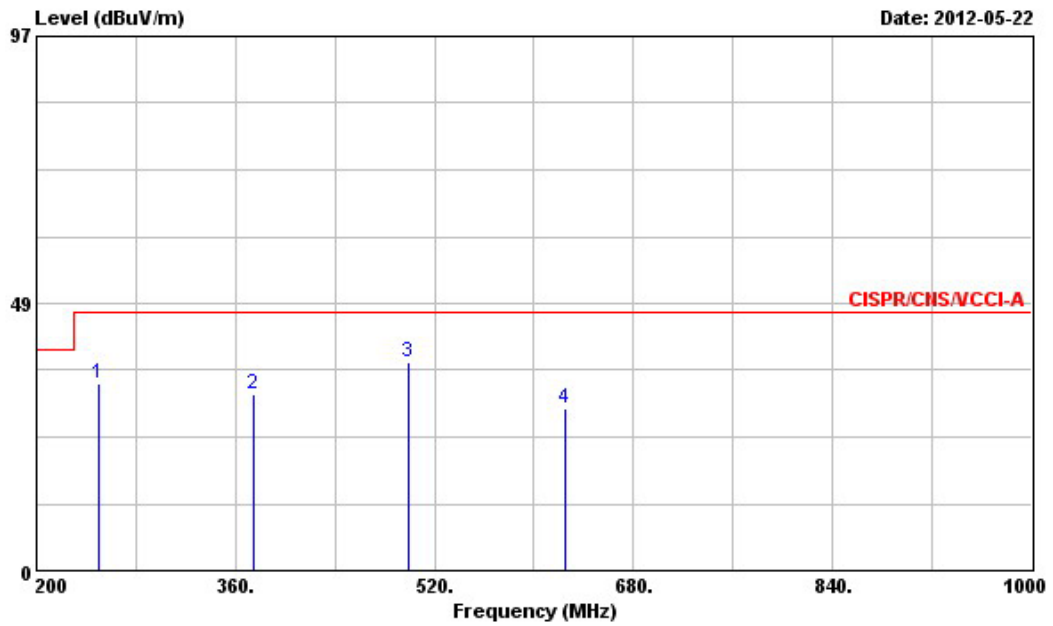

	Freq	Level	Over Limit	Limit Line	ReadAntenna Level	Antenna Factor	Cable Loss	Preamp Factor	Remark	Ant Pos	Table Pos
	MHz	dBuV/m	dB	dBuV/m	dBuV	dB/m	dB	dB		cm	deg
1	249.600	34.05	-12.95	47.00	50.30	12.29	2.88	31.42	Peak	---	---
2	374.400	32.13	-14.87	47.00	44.56	15.14	3.84	31.41	Peak	---	---
3	499.200	37.87	-9.13	47.00	46.93	17.55	4.74	31.35	Peak	---	---
4	624.800	29.28	-17.72	47.00	35.75	19.15	5.67	31.29	Peak	---	---

7.6. Test Result of Radiated Emission for Above 1GHz

Test mode	Mode 2	Test Site No.	03CH03-HY
Test frequency	1 GHz ~ 6 GHz	Test Engineer	Nigel
Temperature	23 °C	Relative Humidity	60 %

Note: 1. Emission level (dB μ V/m) = 20 log Emission level (μ V/m)

2. Corrected Reading : Antenna Factor + Cable Loss + Read Level – Preamp Factor = Level

■ The test was passed at the minimum margin that marked by the frame in the following data

Vertical

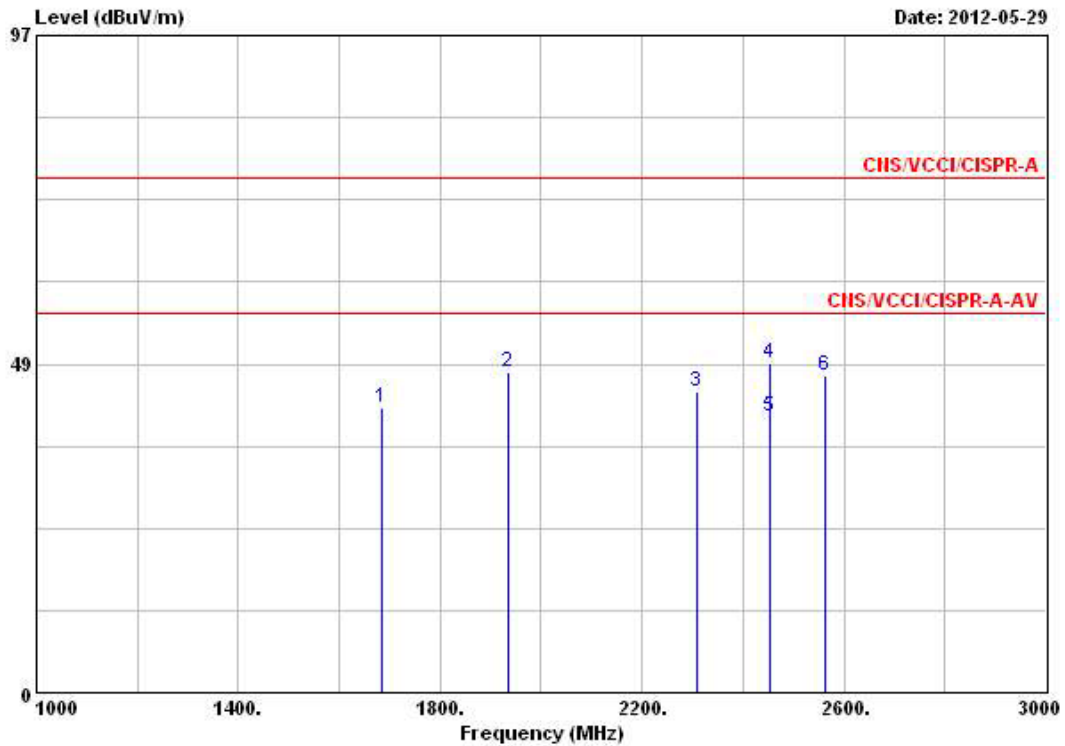

	Freq	Level	Over Limit	Limit Line	Read Level	Antenna Factor	Cable Loss	Preamp Factor	Remark	Ant Pos	Table Pos
	MHz	dBuV/m	dB	dBuV/m	dBuV	dB/m	dB	dB		cm	deg
1	1686.000	41.95	-34.05	76.00	44.83	26.04	3.96	32.88	Peak	---	---
2	1934.000	47.39	-28.61	76.00	48.85	27.19	4.05	32.70	Peak	---	---
3	2310.000	44.51	-31.49	76.00	44.63	28.06	4.54	32.72	Peak	---	---
4	2454.000	48.50	-27.50	76.00	48.19	28.34	4.71	32.74	Peak	---	---
5	2454.000	40.83	-15.17	56.00	40.52	28.34	4.71	32.74	Average	100	154
6	2564.000	46.78	-29.22	76.00	46.04	28.63	4.87	32.76	Peak	---	---

Vertical

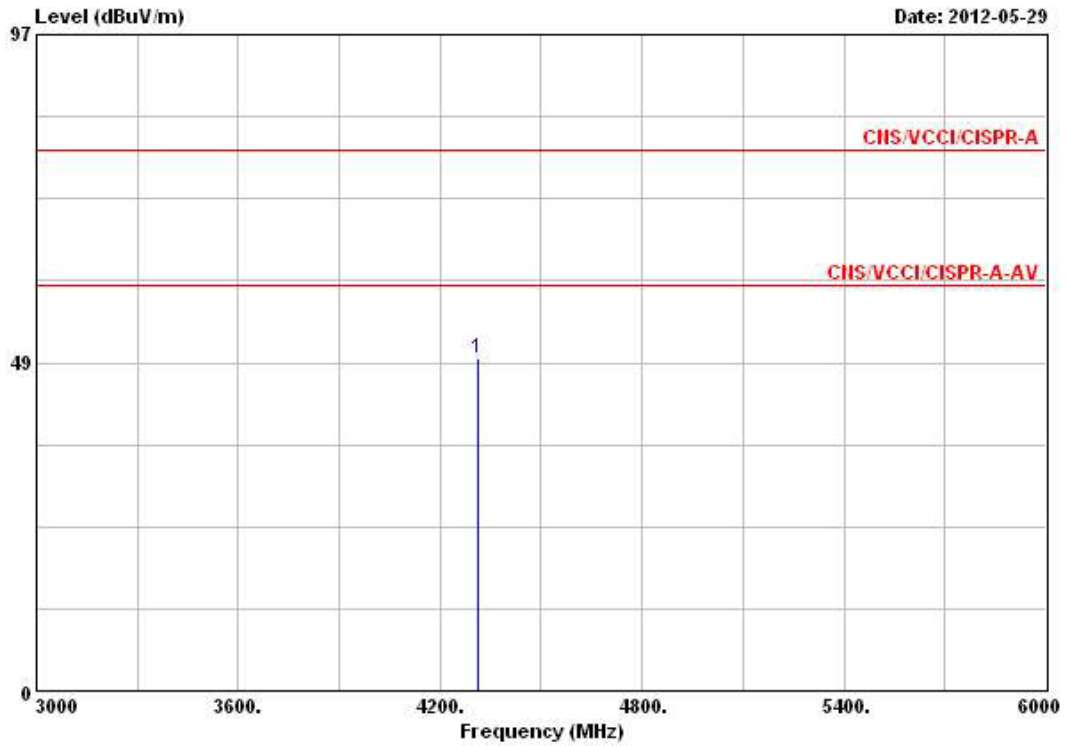

	Freq	Level	Over Limit	Limit Line	ReadAntenna Level	Antenna Factor	Cable Loss	Preamp Factor	Remark	Ant Pos	Table Pos
	MHz	dBuV/m	dB	dBuV/m	dBuV	dB/m	dB	dB		cm	deg
1	4314.000	49.04	-30.96	80.00	43.77	32.44	5.50	32.67	Peak	---	---

Horizontal

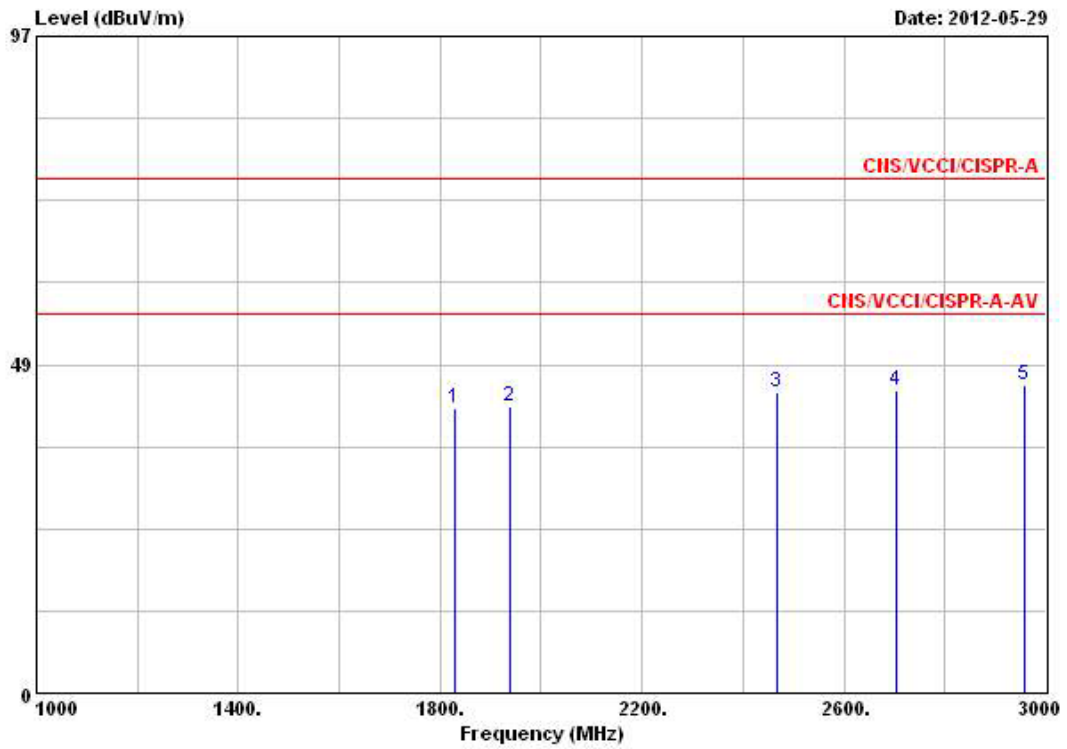

	Freq	Level	Over Limit	Limit Line	ReadAntenna Level	Antenna Factor	Cable Loss	Preamp Factor	Remark	Ant Pos	Table Pos
	MHz	dBuV/m	dB	dBuV/m	dBuV	dB/m	dB	dB		cm	deg
1	1828.000	42.09	-33.91	76.00	44.15	26.73	4.00	32.79	Peak	---	---
2	1940.000	42.44	-33.56	76.00	43.90	27.19	4.05	32.70	Peak	---	---
3	2468.000	44.41	-31.59	76.00	44.05	28.34	4.77	32.75	Peak	---	---
4	2702.000	44.68	-31.32	76.00	43.30	29.08	5.08	32.78	Peak	---	---
5	2958.000	45.54	-30.46	76.00	43.05	29.93	5.39	32.83	Peak	---	---

Horizontal

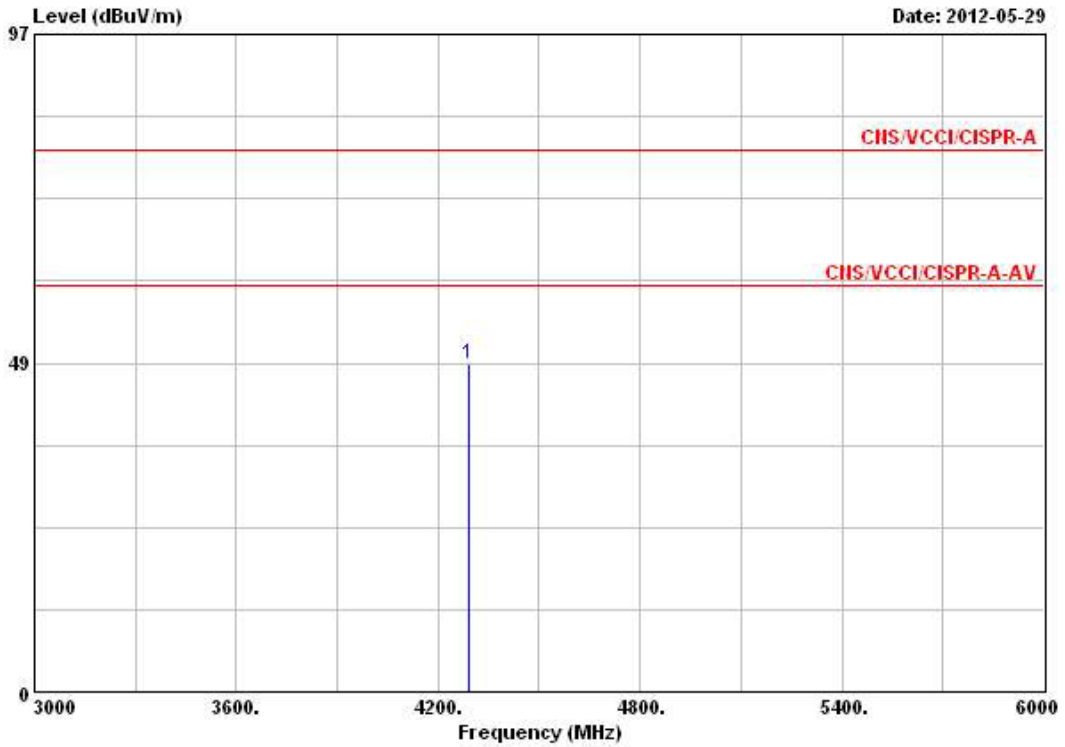

	Freq	Level	Over Limit	Limit Line	ReadAntenna Level	Antenna Factor	Cable Loss	Preamp Factor	Remark	Ant Pos	Table Pos
	MHz	dBuV/m	dB	dBuV/m	dBuV	dB/m	dB	dB		cm	deg
1	4290.000	48.41	-31.59	80.00	43.14	32.44	5.50	32.67	Peak	---	---

8. Harmonic Current Emissions Measurement

8.1. Standard

- Standard : EN 61000-3-2:2006/A1:2009/A2:2009

8.2. Test Procedure

The measured values of the harmonics components of the input current, including line current and neutral current, shall be compared with the limits given in Clause 7 of EN 61000-3-2.

8.3. Test Equipment Settings

Harmonic Parameters	Setting
Line Voltage	230 V
Line Frequency	50 Hz
Device Class	A
Current Measurement Range	High
Measurement Delay	10.0 seconds
Test Duration	10.0 minutes
Class determination Pre-test Duration	10.0 seconds

8.4. Typical Test Setup Layout of Harmonic Current Emissions

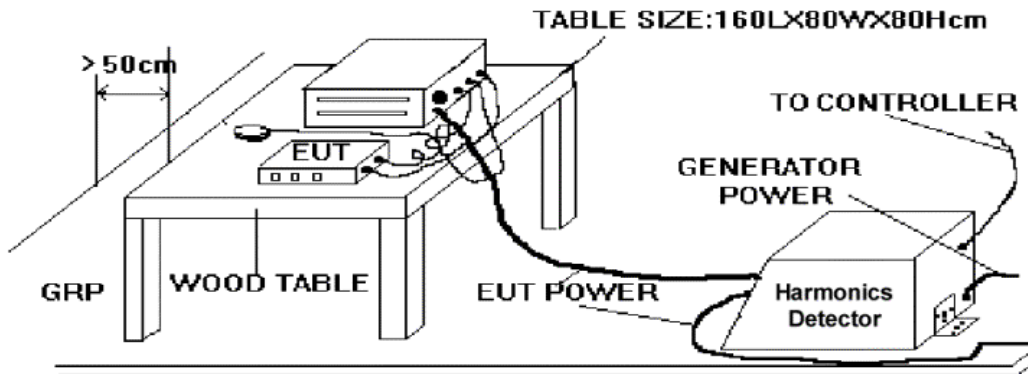

8.5. Test Result of Harmonic Current Emissions

Test mode	Mode 1		
Temperature	25 °C	Final Test Result	<u>PASS</u>
Relative Humidity	49 %	Test Date	Jun. 01, 2012
Atmospheric Pressure	102 kPa	Test Engineer	Andrew Yang

Urms = 230.1V Freq = 50.000 Range: 2 A
 Irms = 0.916A Ipk = 1.549A cf = 1.691
 P = 200.1W S = 210.8VA pf = 0.949
 THDu = 0.10 % Class A

Test - Time : 10min (100 %)

Test completed, Result: PASSED

Order	Freq. [Hz]	Iavg [A]	Iavg% [%]	I _{max} [A]	I _{max} % [%]	Limit [A]	Limits in Ampere			
							90%	100%	150%	200%
1	50	0.8986	98.094	0.8988	98.121					
2	100	0.0000	0.0000	0.0013	0.1466	1.0800	0.9720	1.0800	1.6199	2.1599
3	150	0.1754	19.149	0.1755	19.163	2.3000				
4	200	0.0000	0.0000	0.0004	0.0400	0.4300	0.3870	0.4301	0.6451	0.8601
5	250	0.0266	2.9025	0.0269	2.9318	1.1400	1.0260	1.1400	1.7100	2.2800
6	300	0.0000	0.0000	0.0002	0.0267	0.3000	0.2700	0.3000	0.4501	0.6001
7	350	0.0013	0.1438	0.0055	0.5997	0.7700	0.6930	0.7700	1.1550	1.5400
8	400	0.0000	0.0000	0.0001	0.0133	0.2300	0.2070	0.2300	0.3450	0.4600
9	450	0.0000	0.0000	0.0029	0.3198	0.4000	0.3600	0.4000	0.6000	0.8000
10	500	0.0000	0.0000	0.0001	0.0133	0.1840	0.1656	0.1840	0.2759	0.3679
11	550	0.0077	0.8368	0.0079	0.8662	0.3300	0.2970	0.3300	0.4949	0.6599
12	600	0.0000	0.0000	0.0002	0.0267	0.1533	0.1380	0.1533	0.2300	0.3066
13	650	0.0060	0.6529	0.0061	0.6663	0.2100	0.1890	0.2100	0.3149	0.4199
14	700	0.0000	0.0000	0.0002	0.0267	0.1314	0.1183	0.1315	0.1972	0.2629
15	750	0.0094	1.0254	0.0094	1.0261	0.1500	0.1350	0.1500	0.2250	0.3000
16	800	0.0000	0.0000	0.0002	0.0267	0.1150	0.1035	0.1150	0.1725	0.2300
17	850	0.0000	0.0000	0.0045	0.4931	0.1324	0.1191	0.1323	0.1985	0.2646
18	900	0.0000	0.0000	0.0004	0.0400	0.1022	0.0920	0.1022	0.1533	0.2043
19	950	0.0000	0.0000	0.0031	0.3332	0.1184	0.1066	0.1184	0.1776	0.2368
20	1000	0.0000	0.0000	0.0004	0.0400	0.0920	0.0828	0.0920	0.1381	0.1841
21	1050	0.0000	0.0000	0.0023	0.2532	0.1071	0.0965	0.1072	0.1608	0.2144
22	1100	0.0000	0.0000	0.0004	0.0400	0.0836	0.0753	0.0836	0.1254	0.1672
23	1150	0.0000	0.0000	0.0038	0.4131	0.0978	0.0880	0.0978	0.1467	0.1956
24	1200	0.0000	0.0000	0.0004	0.0400	0.0767	0.0690	0.0767	0.1150	0.1533
25	1250	0.0000	0.0000	0.0033	0.3598	0.0900	0.0810	0.0900	0.1349	0.1799
26	1300	0.0000	0.0000	0.0004	0.0400	0.0708	0.0637	0.0708	0.1062	0.1416
27	1350	0.0114	1.2407	0.0115	1.2527	0.0833	0.0750	0.0834	0.1251	0.1667
28	1400	0.0000	0.0000	0.0002	0.0267	0.0657	0.0591	0.0657	0.0985	0.1313
29	1450	0.0068	0.7382	0.0070	0.7596	0.0776	0.0699	0.0776	0.1165	0.1553
30	1500	0.0000	0.0000	0.0002	0.0267	0.0613	0.0552	0.0613	0.0919	0.1226
31	1550	0.0000	0.0000	0.0051	0.5597	0.0726	0.0654	0.0726	0.1089	0.1453
32	1600	0.0000	0.0000	0.0004	0.0400	0.0575	0.0517	0.0575	0.0862	0.1150
33	1650	0.0115	1.2581	0.0117	1.2793	0.0682	0.0614	0.0682	0.1024	0.1365
34	1700	0.0000	0.0000	0.0005	0.0533	0.0541	0.0487	0.0541	0.0811	0.1082
35	1750	0.0000	0.0000	0.0042	0.4531	0.0643	0.0579	0.0643	0.0965	0.1287
36	1800	0.0000	0.0000	0.0005	0.0533	0.0511	0.0460	0.0511	0.0767	0.1023
37	1850	0.0065	0.7137	0.0072	0.7862	0.0608	0.0547	0.0608	0.0912	0.1216
38	1900	0.0000	0.0000	0.0005	0.0533	0.0484	0.0436	0.0485	0.0727	0.0969
39	1950	0.0123	1.3477	0.0127	1.3859	0.0577	0.0520	0.0577	0.0866	0.1155
40	2000	0.0000	0.0000	0.0004	0.0400	0.0460	0.0414	0.0460	0.0690	0.0920

9. Voltage Fluctuations and Flicker Measurement

9.1. Standard

- Product Standard : EN 61000-3-3:2008

9.2. Test Procedure

The equipment shall be tested under the conditions of **Clause 5**.

The total impedance of the test circuit, excluding the appliance under test, but including the internal impedance of the supply source, shall be equal to the reference impedance. The stability and tolerance of the reference impedance shall be adequate to ensure that the overall accuracy of $\pm 8\%$ is achieved during the whole assessment procedure.

9.3. Test Equipment Settings

Flicker Parameters	Setting
Line Voltage	230 V
Line Frequency	50 Hz
Measurement Delay	10.0 seconds
Pst Integration Time	10.0 minutes
Pst Integration Periods	1
Test Duration	10.0 minutes

9.4. Typical Test Setup Layout of Voltage Fluctuations and Flicker

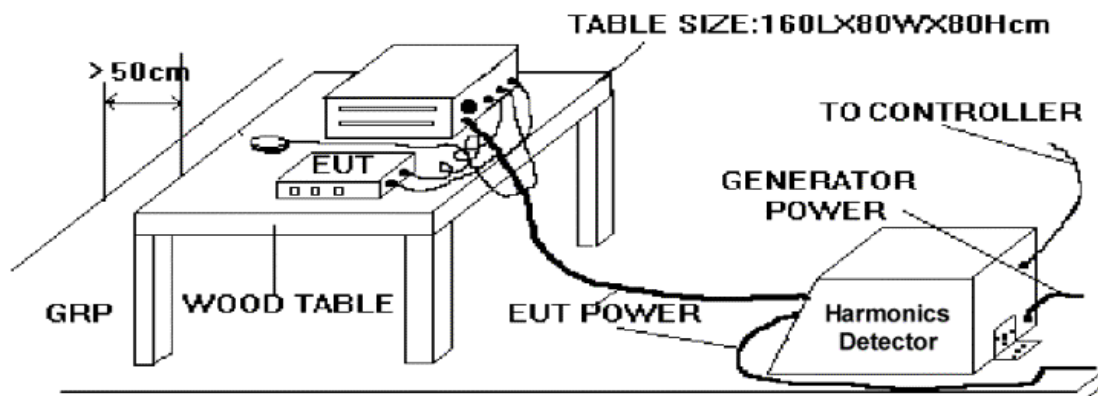



9.5. Test Result of Voltage Fluctuation and Flicker

Test mode	Mode 1		
Temperature	25 °C	Final Test Result	<u>PASS</u>
Relative Humidity	49 %	Test Date	Jun. 01, 2012
Atmospheric Pressure	102 kPa	Test Engineer	Andrew Yang

Urms = 230.1V Freq = 49.987 Range: 2 A
 Irms = 0.917A Ipk = 1.547A cf = 1.687
 P = 200.4W S = 211.0VA pf = 0.950

Test - Time : 1 x 10min = 10min (100 %)

LIN (Line Impedance Network) : SLIN 0.24ohm +j0.15ohm N:0.16ohm +j0.10ohm

Limits : Plt : 0.65 Pst : 1.00
 dmax : 4.00 % dc : 3.30 %
 dtLim: 3.30 % dt>Lim: 500ms

Test completed, Result: PASSED

	Pst	P50s	P10s	P3s	P1s	P0.1s	dmax	dc	dt>Lim
1	0.072	0.010	0.010	0.010	0.010	0.010	0.000	0.000	0.000

10. Electrostatic Discharge Immunity Measurement (ESD)

- Final Test Result : **PASS**
- Pass Performance Criteria : **B**
- Required Performance Criteria : B
- Basic Standard : IEC 61000-4-2:2008
- Product Standard : EN 55024:2010
- Level : 3 for air discharge
: 2 for contact discharge
- Test Voltage : $\pm 2 / \pm 4 / \pm 8$ KV for air discharge
: $\pm 2 / \pm 4$ KV for contact discharge
- Discharge Impedance : 330 ohm / 150 pF
- Temperature : 22 °C
- Relative Humidity : 42 %
- Atmospheric Pressure : 102 kPa
- Test Date : Jun. 06, 2012
- Test Engineer : Andrew Yang
- Observation : When testing at contact discharge ± 4 kV on screw, CONSOLE, RJ45 port, FIBER and HCP, the light flickered and the EUT reset automatically. After the test, the equipment continued to operate as intended without operator intervention.

10.1. Test Setup

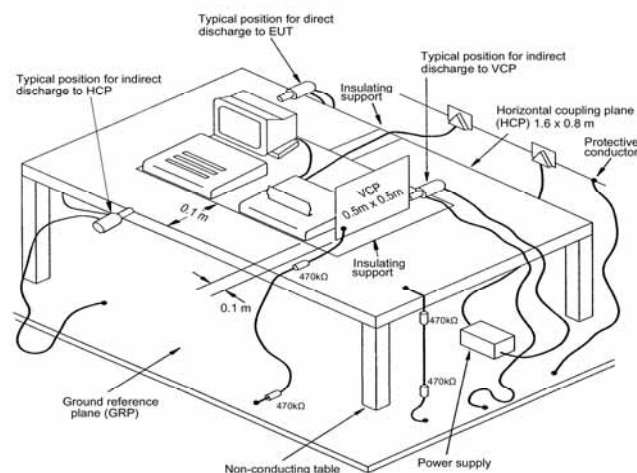

The test setup consists of the test generator, EUT and auxiliary instrumentation necessary to perform DIRECT and INDIRECT application of discharges to the EUT as applicable, in the follow manner:

- a. CONTACT DISCHARGE to the conductive surfaces and to coupling plane;
- b. AIR DISCHARGE at insulating surfaces.

The preferred test method is that of type tests performed in laboratories and the only accepted method of demonstrating conformance with this standard. The EUT was arranged as closely as possible to arrangement in final installed conditions.

10.2. Test Setup for Tests Performed in Laboratory

A ground reference plane was provided on the floor of the test site. It was a metallic sheet (copper or aluminum) of 0.25 mm, minimum thickness; other metallic may be used but they shall have at least 0.65 mm thickness. In the SPORTON EMC LAB., we provided 1 mm thickness aluminum ground reference plane or 1 mm thickness stainless steel ground reference plane. The minimum size of the ground reference plane is 1 m x 1 m, the exact size depending on the dimensions of the EUT. It was connected to the protective grounding system.

The EUT was arranged and connected according to its functional requirements. A distance of 1 m minimum was provided between the EUT and the wall of the Lab., and any other metallic structure. In cases where this length exceeds the length necessary to apply the discharges to the selected points, the excess length shall, where possible, be placed non-inductively off the ground reference plane and shall not come closer than 0.2 m to other conductive parts in the test setup.

Where the EUT is installed on a metal table, the table was connected to the reference plane via a cable with a 470k ohm resistor located at each end, to prevent a build-up of charge. The test setup was consist a wooden table, 0.8 m high, standing on the ground reference plane. A HCP, 1.6 m x 0.8 m, was placed on the table. The EUT and cables was isolated from the HCP by an insulating support 0.5 mm thick. The VCP size, 0.5 m x 0.5 m.

10.3. ESD Test Procedure

- a. In the case of air discharge testing the climatic conditions shall be within the following ranges:
 - ambient temperature: 15 °C to 35 °C;
 - relative humidity : 30 % to 60 %;
 - atmospheric pressure : 86 kPa (860 mbar) to 106 kPa (1060 mbar).
- b. Test programs and software shall be chosen so as to exercise all normal modes of operation of the EUT. The use of special exercising software is encouraged, but permitted only where it can be shown that the EUT is being comprehensively exercised.
- c. The test voltage shall be increased from the minimum to the selected test severity level, in order to determine any threshold of failure. The final severity level should not exceed the product specification value in order to avoid damage to the equipment.
- d. The test shall be performed with both air discharge and contact discharge. On preselected points at least 10 single discharges (in the most sensitive polarity) shall be applied on air discharge. On preselected points at least 25 single discharges (in the most sensitive polarity) shall be applied on contact discharge.
- e. For the time interval between successive single discharges an initial value of one second is recommended. Longer intervals may be necessary to determine whether a system failure has occurred.
- f. In the case of contact discharges, the tip of the discharge electrode shall touch the EUT before the discharge switch is operated.
- g. In the case of painted surface covering a conducting substrate, the following procedure shall be adopted:
 - If the coating is not declared to be an insulating coating by the equipment manufacturer, then the pointed tip of the generator shall penetrate the coating so as to make contact with the conducting substrate.
 - Coating declared as insulating by the manufacturer shall only be submitted to the air discharge.
 - The contact discharge test shall not be applied to such surfaces.
- h. In the case of air discharges, the round discharge tip of the discharge electrode shall be approached as fast as possible (without causing mechanical damage) to touch the EUT. After each discharge, the ESD generator (discharge electrode) shall be removed from the EUT. The generator is then retriggered for a new single discharge. This procedure shall be repeated until the discharges are completed. In the case of an air discharge test, the discharge switch, which is used for contact discharge, shall be closed.

10.4. Test Severity Levels

10.4.1. Contact Discharge

Level	Test Voltage (KV) of Contact discharge
1	±2
2	±4
3	±6
4	±8
X	Specified

Remark : "X" is an open level.

10.4.2. Air Discharge

Level	Test Voltage (KV) of Air Discharge
1	±2
2	±4
3	±8
4	±15
X	Specified

Remark : "X" is an open level.

10.5. Test Points

10.5.1. Test Result of Air Discharge

Test Method	No. of Discharges	Air Discharge/Round Tip						Test Record
		+2kV	-2kV	+4kV	-4kV	-8kV	+8kV	
Reset Switching	10	ND	ND	ND	ND	ND	ND	Note ¹
LED	10	ND	ND	ND	ND	ND	ND	Note ¹
AC SOCKET	10	ND	ND	ND	ND	ND	ND	Note ¹
Remark	1. The "ND" is means No Discharge.							

10.5.2. Test Result of Contact Discharge

Direct discharge

Test Method	No. of Discharges	Contact Discharge/Pointed Tip				Test Record
		+2kV	-2kV	+4kV	-4kV	
CASE	25	A	A	A	A	None
screw	25	A	A	B	B	Note ¹
RJ45 port	25	A	A	B	B	Note ¹
CONSOLE	25	A	A	B	B	Note ¹
FIBER	25	A	A	B	B	Note ¹
Remark	1. The "Note ¹ " is means when testing at contact discharge $\pm 4kV$ on screw, CONSOLE, RJ45 port and FIBER, the light flickered and the EUT reset automatically. After the test, the equipment continued to operate as intended without operator intervention.					

Indirect discharge to HCP and VCP

Test Method	No. of Discharges	Contact Discharge/Pointed Tip				Test Record
		+2kV	-2kV	+4kV	-4kV	
HCP (At Front)	25	A	A	B	B	Note ¹
HCP (At Left)	25	A	A	B	B	Note ¹
HCP (At Right)	25	A	A	B	B	Note ¹
HCP (At Rear)	25	A	A	B	B	Note ¹
VCP (At Front)	25	A	A	A	A	None
VCP (At Left)	25	A	A	A	A	None
VCP (At Right)	25	A	A	A	A	None
VCP (At Rear)	25	A	A	A	A	None
Remark	1. 1. The "Note ¹ " is means when testing at contact discharge $\pm 4kV$ on HCP, the light flickered and the EUT reset automatically. After the test, the equipment continued to operate as intended without operator intervention.					

11. Radio Frequency Electromagnetic Field Immunity Measurement (RS)

- Final Test Result : **PASS**
- Pass Performance Criteria : **A**
- Required Performance Criteria : A
- Basic Standard : IEC 61000-4-3:2006/A1:2007/A2:2010
- Product Standard : EN 55024:2010
- Level : 2
- Frequency Range : 80-1000 MHz
- Additional Selection Frequency : 80, 120, 160, 230, 434, 460, 600, 863, 900MHz
- Dwell Time : 2.9 seconds
- Frequency Step size : 1 % of the preceding frequency value
- Field Strength : 3 V/m (unmodulated, r.m.s) 80% AM (1 kHz)
- Temperature : 25 °C
- Relative Humidity : 49 %
- Atmospheric Pressure : 102 kPa
- Test Date : Jun. 06, 2012
- Test Engineer : Andrew Yang

11.1. Test Record

Frequency Band: 80-1000 MHz

Sides of the EUT have been exposed to the field	Antenna positioned	Test field strength Level	Test field strength (V/m)	Observation
Front	Vertical	2	3	Normal (No influencing)
	Horizontally	2	3	Normal (No influencing)
Left	Vertical	2	3	Normal (No influencing)
	Horizontally	2	3	Normal (No influencing)
Back	Vertical	2	3	Normal (No influencing)
	Horizontally	2	3	Normal (No influencing)
Right	Vertical	2	3	Normal (No influencing)
	Horizontally	2	3	Normal (No influencing)

11.2. Test Setup

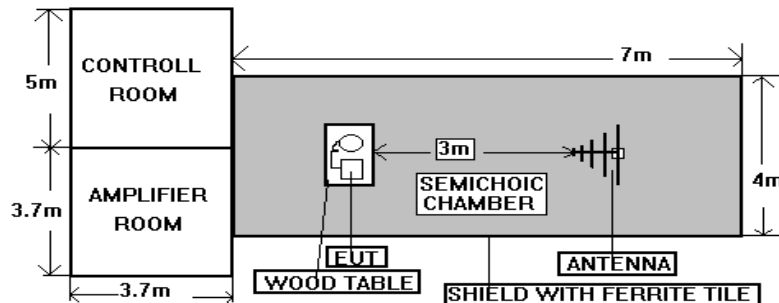

NOTE : The SPORTON 7m x 4m x 4m semi-anechoic chamber is compliance with the sixteen point's uniform field requirement as stated in IEC 61000-4-3 Section 6.2.

The procedure defined in this part requires the generation of electromagnetic fields within which the test sample is placed and its operation observed. To generate fields that are useful for simulation of actual (field) conditions may require significant antenna drive power and the resultant high field strength levels. To comply with local regulations and to prevent biological hazards to the testing personnel, it is recommended that these tests be carried out in a shielded enclosure or semi-anechoic chamber.

11.3. Test Procedure

- a. The equipment to be tested is placed in the center of the enclosure on a wooden table. The equipment is then connected to power and signal leads according to pertinent installation instructions.
- b. The bilog antenna which is enabling the complete frequency range of 80-1000MHz is placed 3m away from the equipment. The required field strength is determined by placing the field strength meter(s) on top of or directly alongside the equipment under test and monitoring the field strength meter via a remote field strength indicator outside the enclosure while adjusting the continuous-wave to the applicable antennae.
- c. The test is normally performed with the generating antenna facing each of four sides of the EUT. The polarization of the field generated by the broadband (bilog) antenna necessitates testing each position twice, once with the antenna positioned vertically and again with the antenna positioned horizontally.
- d. The dwell time at each frequency shall not be less than the time necessary for the EUT to be exercised, and able to respond. Sensitive frequencies e.g. clock frequency(ies) and harmonics or frequencies of dominant interest shall be analyzed separately.
- e. At each of the above conditions, the frequency range is swept 80-1000MHz, pausing to adjust the R.F. signal level or to switch oscillators and antenna. The rate of sweep is in the order of 1.5×10^{-3} decades/s. The sensitive frequencies or frequencies of dominant interest may be discretely analyzed.

11.4. Test Severity Levels

Frequency Band : 80-1000MHz

Level	Test field strength (V/m)
1	1
2	3
3	10
X	Specified

Remark : "X" is an open class.

12. Electrical Fast Transient/Burst Immunity Measurement (EFT/BURST)

- Final Test Result : **PASS**
- Pass Performance Criteria : **B** on Input power ports
A on signal ports and telecommunication ports
- Required Performance Criteria : B
- Basic Standard : IEC 61000-4-4:2004/A1:2010
- Product Standard : EN 55024:2010
- Level : on Input power ports -- 2
on signal ports and telecommunication ports -- 2
- Test Voltage : on Input power ports -- $\pm 0.5 / \pm 1.0$ kV
on signal ports and telecommunication ports -- $\pm 0.25 / \pm 0.5$ kV
- Impulse wave shape : 5/50 ns (Tr/Th)
- Impulse frequency : 5 kHz
- Temperature : 25 °C
- Relative Humidity : 49 %
- Atmospheric Pressure : 102 kPa
- Test Date : Jun. 06, 2012
- Test Engineer : Andrew Yang

12.1. Test Record

Test port	Polarity	Test Level	Voltage (kV)	Observation
Input power port	+	2	0.5 / 1.0	When testing at ± 1 kV on the L1, L2 and PE Line, the light flickered. After the test, the equipment continued to operate as intended without operator intervention.
	-	2	0.5 / 1.0	
signal port and telecommunication ports	+	2	0.25 / 0.5	Normal (No influencing)
	-	2	0.25 / 0.5	Normal (No influencing)

Remark : Other cable applied exemption. (Cable lengths < 3m)

12.2. Test setup

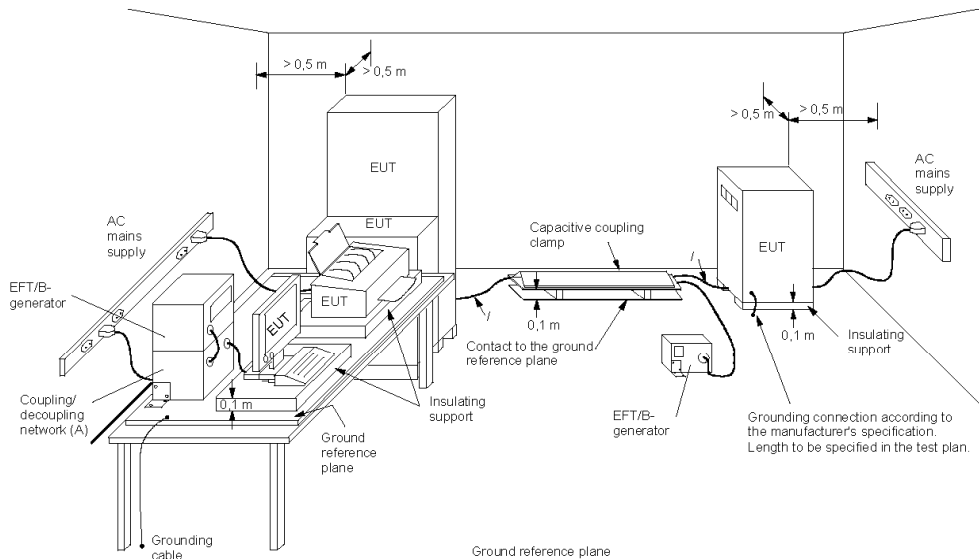

Key

- l* length between clamp and the EUT to be tested (should be 0,5 m ± 0,05 m)
- (A) location for supply line coupling
- (B) location for signal lines coupling

The EUT was placed on a ground reference plane and was insulated from it by an insulating support about 0.1 m thick. If the EUT is table-top equipment, it was located approximately 0.8 m above the GRP. The GRP was a metallic sheet (copper or aluminum) of 0.25 mm, minimum thickness; other metallic may be used but they shall have at least 0.65 mm thickness. It shall project beyond the EUT by at least 0.1 m on all sides and connected to the protective earth. In the SPORTON EMC LAB., We provided 1 mm thickness aluminum ground reference plane or 1 mm thickness stainless steel ground reference plane. The minimum size of the ground reference plane is 1 m x 1 m, the exact size depending on the dimensions of the EUT. It was connected to the protective grounding system. The EUT was arranged and connected according to its functional requirements. The minimum distance between the EUT and other conductive structures, except the GRP. Beneath the EUT, was more than 0.5 m. using the coupling clamp, the minimum distance between the coupling plates and all other conductive structures, except the GRP. Beneath the EUT, was more than 0.5 m. The length of the signal and power lines between the coupling device and the EUT was 1 m or less.

12.3. Test on Power Line

- a. The EFT/B-generator was located on the GRP. The length from the EFT/B-generator to the EUT as not exceeds 1 m.
- b. The EFT/B-generator provides the ability to apply the test voltage in a non-symmetrical condition to the power supply input terminals of the EUT.

12.4. Test on Communication Lines

- a. The coupling clamp is composed of a clamp unit for housing the cable (length more than 3 m), and was placed on the GRP.
- b. The coupling clamp provides the ability of coupling the fast transient/bursts to the cable under test.

12.5. Test Procedure

- a. In order to minimize the effect of environmental parameters on test results, the climatic conditions when test is carrying out shall comply with the following requirements:
 - ambient temperature: 15 °C to 35 °C;
 - relative humidity : 45 % to 75 %;
 - atmospheric pressure : 86 kPa (860 mbar) to 106 kPa (1060 mbar).
- b. In order to minimize the effect of environmental parameters on test results, the electromagnetic environment of the laboratory shall not influence the test results.
- c. The variety and diversity of equipment and systems to be tested make it difficult to establish general criteria for the evaluation of the effects of fast transients/bursts on equipment and systems.
- d. The test results may be classified on the basic of the operating conditions and the functional specification of the equipment under test, according to the following performance criteria :
 - Normal performance within the specification limits.
 - Temporary degradation or loss of function or performance which is self-recoverable.
 - Temporary degradation or loss of function or performance which requires operator intervention or system reset.
 - Degradation or loss of function which is not recoverable due to damage of equipment (components).

12.6. Test Severity Levels

The following test severity levels are recommended for the fast transient/burst test :

Open circuit output test voltage ± 10%		
Level	On Input power ports	On signal port and telecommunication ports
1	0.5 KV	0.25 KV
2	1.0 KV	0.50 KV
3	2.0 KV	1.00 KV
4	4.0 KV	2.00 KV
X	Specified	Specified

Remark : " X " is an open level.
The level is subject to negotiation between the user and the manufacturer or is specified by the manufacturer.

13. Surge Immunity Measurement

- Final Test Result : **PASS**
- Pass Performance Criteria : **A** on Input power ports
B on signal ports and telecommunication ports
- Required Performance Criteria : B for Input power ports
: C for signal ports and telecommunication ports
- Basic Standard : IEC 61000-4-5:2005
- Product Standard : EN 55024:2010
- Surge wave form (Tr/Th) : on Input power ports -- 1.2/50 (8/20) μ s
: on signal ports and telecommunication ports -- 10/700 μ s
- Level : on Input power ports -- 3
: on signal ports and telecommunication ports -- 2
- Test Voltage : on Input power ports -- $\pm 0.5 / \pm 1.0 / \pm 2.0$ kV
: on signal ports and telecommunication ports -- ± 1.0 kV
- Phase Angle : 0°, 90°, 180°, 270°
- Number of surges : 5 positive and 5 negative pulses
- Pulse Repetition Rate : 1 time / min. (maximum)
- Temperature : 25 °C
- Relative Humidity : 49 %
- Atmospheric Pressure : 102 kPa
- Test Date : Jun. 06, 2012
- Test Engineer : Andrew Yang

13.1. Test Record

■ **Input power port:**

Test Location	Voltage (kV)	Polarity	Phase Angle				Observation
			0	90	180	270	
L - N	0.5	+	A	A	A	A	Normal (No influencing)
		-	A	A	A	A	Normal (No influencing)
	1.0	+	A	A	A	A	Normal (No influencing)
		-	A	A	A	A	Normal (No influencing)
L - PE	0.5	+	A	A	A	A	Normal (No influencing)
		-	A	A	A	A	Normal (No influencing)
	1.0	+	A	A	A	A	Normal (No influencing)
		-	A	A	A	A	Normal (No influencing)
	2.0	+	A	A	A	A	Normal (No influencing)
		-	A	A	A	A	Normal (No influencing)
N - PE	0.5	+	A	A	A	A	Normal (No influencing)
		-	A	A	A	A	Normal (No influencing)
	1.0	+	A	A	A	A	Normal (No influencing)
		-	A	A	A	A	Normal (No influencing)
	2.0	+	A	A	A	A	Normal (No influencing)
		-	A	A	A	A	Normal (No influencing)

Remark : PE = Earth reference

■ **Ports for signal port and telecommunication port:**

Test Location	Voltage (kV)	Polarity	Criteria	Observation
Line- Ground	1.0	+	B	When testing at ±1kV on RJ45 port, the Ping loss and the light flickered. After the test, the equipment continued to operate as intended without operator intervention.
		-	B	

13.2. Test Severity Levels

Level	Open-circuit test voltage, ± 10%, KV
1	0.5
2	1.0
3	2.0
4	4.0
x	Specified
Remark : " X " is an open level. This level can be specified in the product specification.	

13.3. Test Procedure

a. Climatic conditions

The climatic conditions shall comply with the following requirements :

- ambient temperature : 15 °C to 35 °C
- relative humidity : 10 % to 75 %
- atmospheric pressure : 86 kPa to 106 kPa (860 mbar to 1060 mbar)

b. Electromagnetic conditions

The electromagnetic environment of the laboratory shall not influence the test results.

c. The test shall be performed according the test plan that shall specify the test set-up with

- generator and other equipment utilized;
- test level (voltage/current);
- generator source impedance;
- internal or external generator trigger;
- number of tests : at least five positive and five negative at the selected points;
- repetition rate : maximum 1/min.
- inputs and outputs to be tested;
- representative operating conditions of the EUT;
- sequence of application of the surge to the circuit;
- phase angle in the case of a.c. power supply;
- actual installation conditions, for example :
AC : neutral earthed,
DC : (+) or (-) earthed to simulated the actual earthing conditions.

d. If not otherwise specified the surges have to be applied synchronized to the voltage phase at the zero-crossing and the peak value of the a.c. voltage wave (positive and negative).

e. The surges have to be applied line to line and line(s) and earth. When testing line to earth, the test voltage has to be applied successively between each of the lines and earth, if there is no other specification.

f. The test procedure shall also consider the non-linear current-voltage characteristics of the equipment



under test. Therefore the test voltage has to be increased by steps up to the test level specified in the product standard or test plan.

- g. All lower levels including the selected test level shall be satisfied. For testing the secondary protection, the output voltage of the generator shall be increased up to the worst-case voltage breakdown level (let-through level) of the primary protection.
- h. If the actual operating signal sources are not available, they may be simulated. Under no circumstances may the test level exceed the product specification. The test shall be carried out according to the test plan.
- i. To find all critical points of the duty cycle of the equipment, a sufficient number of positive and negative test pulses shall be applied. For acceptance test previously unstressed equipment shall be used to the protection devices shall be replaced.

13.4. Operating Condition

Full system

14. Conducted Disturbances Induced by Radio-Frequency Field Immunity Measurement (CS)

- Final Test Result : **PASS**
- Pass Performance Criteria : **A**
- Required Performance Criteria : A
- Basic Standard : IEC 61000-4-6:2008
- Product Standard : EN 55024:2010
- Level : 2
- Test Voltage : 3 V (unmodulated, r.m.s) 80% AM (1 kHz)
- Frequency Range : 0.15 MHz to 80 MHz
- Additional Selection Frequency : 0.2, 1, 7.1, 13.56, 21, 27.12, 40.68MHz
- Dwell time : 2.9 seconds
- Frequency step size : 1 % of the preceding frequency value
- Coupling mode : CDN-M2+M3 for Input power ports
: CDN-T800 for signal ports and telecommunication ports
- Temperature : 25 °C
- Relative Humidity : 49 %
- Atmospheric Pressure : 102 kPa
- Test Date : Jun. 06, 2012
- Test Engineer : Andrew Yang

14.1. Test Record

Test port	Test field strength level	Test field strength (V rms)	Observation
Input ac power port	2	3	Normal (No influencing)
signal port and telecommunication ports	2	3	Normal (No influencing)

Remark : Other cable applied exemption. (Cable lengths < 3m)

14.2. Test Severity Levels

Level	Voltage Level (EMF)
1	1 V rms
2	3 V rms
3	10 V rms
x	Specified

Remark : " X " is an open level.
This level can be specified in the product specification.

14.3. Operating Condition

Full system

14.4. Test Procedure

- a. The EUT shall be operated within its intended climatic conditions. The temperature and relative humidity should be recorded.
- b. This test method test can be performed without using a sell shielded enclosure. This is because the disturbance levels applied and the geometry of the setups are not likely to radiated a high amount of energy, especially at the lower frequencies. If under certain circumstances the radiated energy is too high, a shielded enclosure has to be used.
- c. The test shall be performed with the test generator connected to each of the coupling and decoupling devices in turn while the other non-excited RF-input ports of the coupling devices are terminated by a 50 ohm load resistor.
- d. The frequency range is swept from 150 kHz to 80 MHz, using the signal levels established during the setting process, and with the disturbance signal 80% amplitude modulated with a 1kHz sine wave, pausing to adjust the RF-signal level or to switch coupling devices as necessary. The rate of sweep shall no exceed 1.5×10^{-3} decades/s. Where the frequency is swept incrementally, the step size shall no exceed 1% of the start and thereafter 1% of the preceding frequency value.
- e. The dwell time at each frequency shall not be less than the time necessary for the EUT to be exercised, and able to respond. Sensitive frequencies e.g. clock frequency(ies) and harmonics or frequencies of dominant interest shall be analyzed separately.
- f. In cases of dispute, the test procedure using a step size not exceeding 1% of the start and thereafter 1% of preceding frequency value shall take precedence.
- g. Attempts should be made to fully exercise the EUT during testing, and to fully interrogate all exercise modes selected for susceptibility.
- h. The use of special exercising programs is recommended.
- i. Testing shall be performed according to a Test Plan, which shall be included in the test report.
- j. It may be necessary to carry out some investigatory testing in order to establish some aspects of the test plan.

15. Power Frequency Magnetic Field immunity Measurement (PFMF)

- Final Test Result : **PASS**
- Pass Performance Criteria : **A**
- Required Performance Criteria : A
- Basic Standard : IEC 61000-4-8:2009
- Product Standard : EN 55024:2010
- Temperature : 25 °C
- Relative Humidity : 49 %
- Atmospheric Pressure : 102 kPa
- Test Date : Jun. 06, 2012
- Test Engineer : Andrew Yang

15.1. Test Record

Power Frequency Magnetic Field	Testing duration	Coil Orientation	Observation
50/60Hz, 1A/m	1.0 Min	X-axis	Normal (No influencing)
50/60Hz, 1A/m	1.0 Min	Y-axis	Normal (No influencing)
50/60Hz, 1A/m	1.0 Min	Z-axis	Normal (No influencing)

15.2. Test Setup

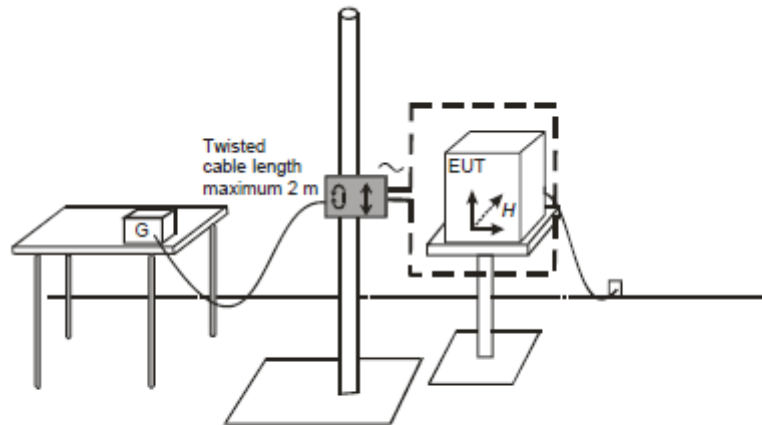

EUT : Equipment under test G : Test Generator

16. Voltage Dips and Voltage Interruptions Immunity Measurement (DIP)

- Final Test Result : **PASS**
- Pass Performance Criteria : **C** for voltage interruption, **C/A** for voltage dips - 100V
C for voltage interruption, **A/A** for voltage dips - 240V
- Required Performance Criteria : C for voltage interruption, C/B for voltage dips
- Basic Standard : IEC 61000-4-11:2004
- Product Standard : EN 55024:2010
- Test Port : Input power ports
- Phase Angle : 0°, 45°, 90°, 135°, 180°, 225°, 270°, 315°, 360°
- Temperature : 25 °C
- Relative Humidity : 49 %
- Atmospheric Pressure : 102 kPa
- Test Date : Jun. 06, 2012
- Test Engineer : Andrew Yang

16.1. Test Record of Voltage Interruption

Voltage (V)	Performance Criterion (Phase Angle)									Reduction Voltage	Duration (Periods)	Observation
	0	45	90	135	180	225	270	315	360			
100/240	C	C	C	C	C	C	C	C	C	>95 %	250	After the interruption, the power of EUT reset automatically.

16.2. Test Record of Voltage Dips

Voltage (V)	Performance Criterion (Phase Angle)									Reduction Voltage	Duration (Periods)	Observation
	0	45	90	135	180	225	270	315	360			
100	C	C	C	C	C	C	C	C	C	30 %	25	After the interruption, the power of EUT reset automatically.
100	A	A	A	A	A	A	A	A	A	>95 %	0.5	Normal (No influencing)

Voltage (V)	Performance Criterion (Phase Angle)									Reduction Voltage	Duration (Periods)	Observation
	0	45	90	135	180	225	270	315	360			
240	A	A	A	A	A	A	A	A	A	30 %	25	Normal (No influencing)
240	A	A	A	A	A	A	A	A	A	>95 %	0.5	Normal (No influencing)

16.3. Testing Requirement and Procedure

The test was based on IEC 61000-4-11:2004

16.4. Test Conditions

1. Source voltage and frequency : 100/240V, 50Hz, Single phase.
2. Test of interval : 10 sec.
3. Level and duration : Sequency of 3 dips/interrupts.
4. Voltage rise (and fall) time : 1 ~ 5 μ s.

16.5. Operating Condition

Full system

17. Photographs of Test Configuration

17.1. Photographs of AC Powerline Conducted Emissions and Disturbances at Telecommunication ports Test Configuration

- The photographs show the configuration that generates the maximum emission.

FRONT VIEW



REAR VIEW

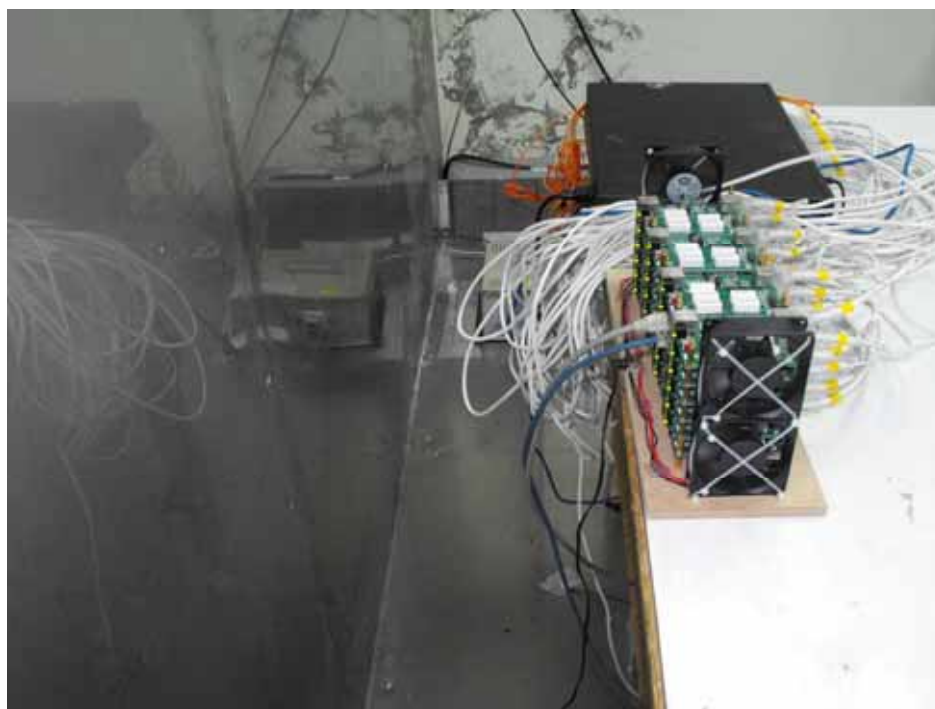

17.2. Photographs of Radiated Emissions Test Configuration

- The photographs show the configuration that generates the maximum emission.
For Below 1GHz

FRONT VIEW



REAR VIEW



- The photographs show the configuration that generates the maximum emission.
For Above 1GHz

FRONT VIEW

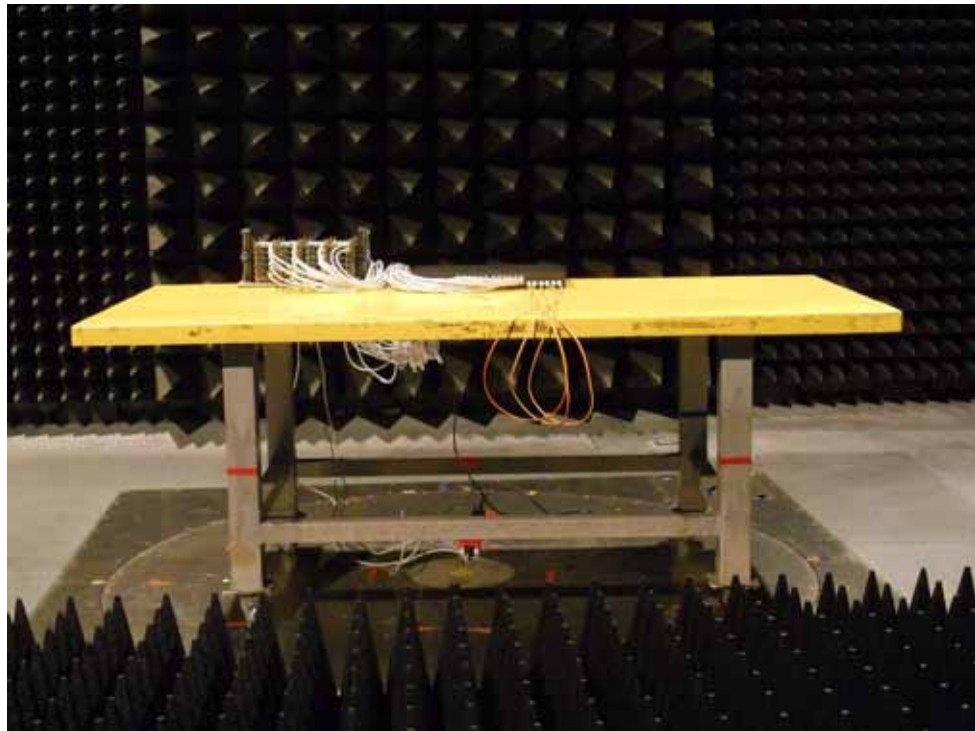

REAR VIEW



17.3. Photographs of Harmonic, Flicker, Surge, Dip Test Configuration

FRONT VIEW



REAR VIEW

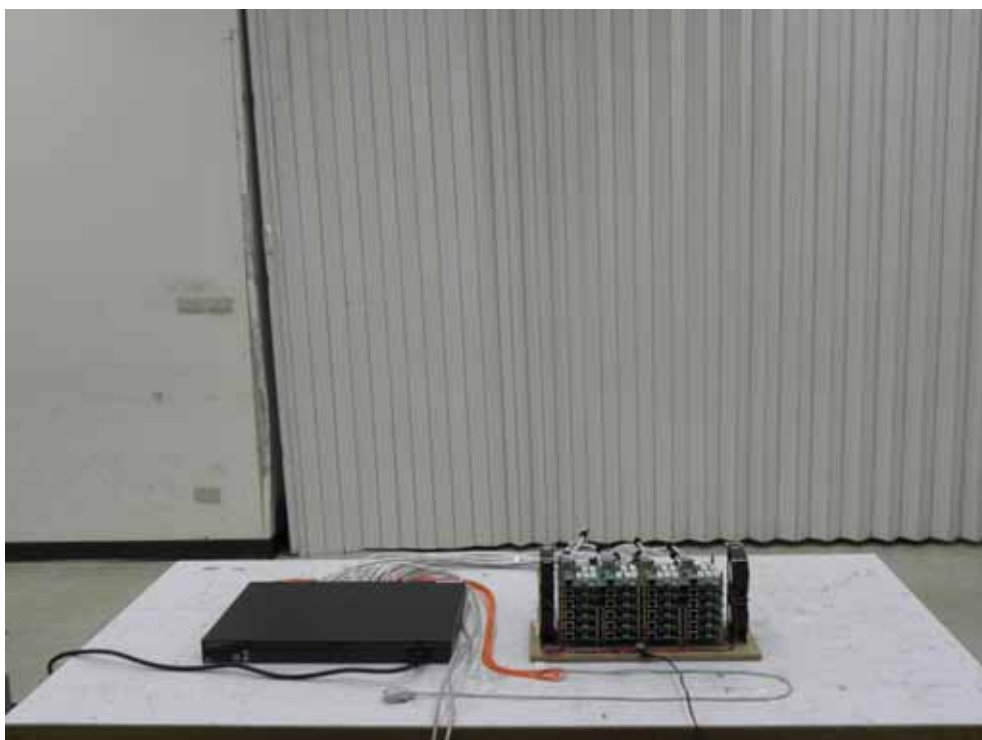

17.4. Photographs of ESD Immunity Test Configuration

FRONT VIEW

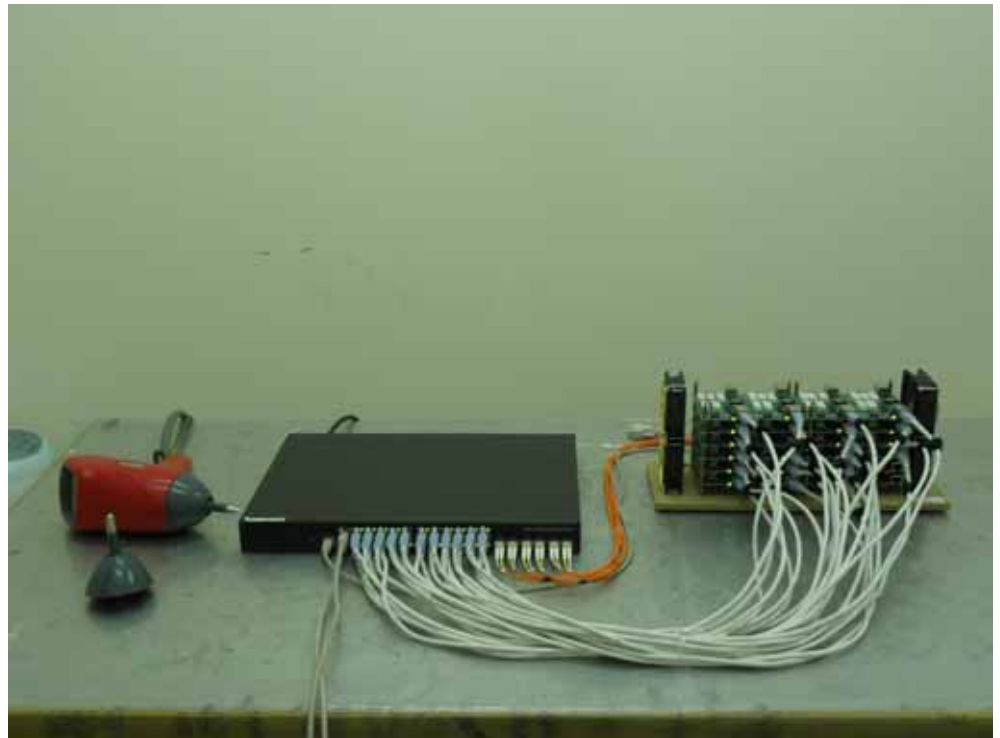

REAR VIEW



17.5. Photographs of RS Immunity Test Configuration

FRONT VIEW

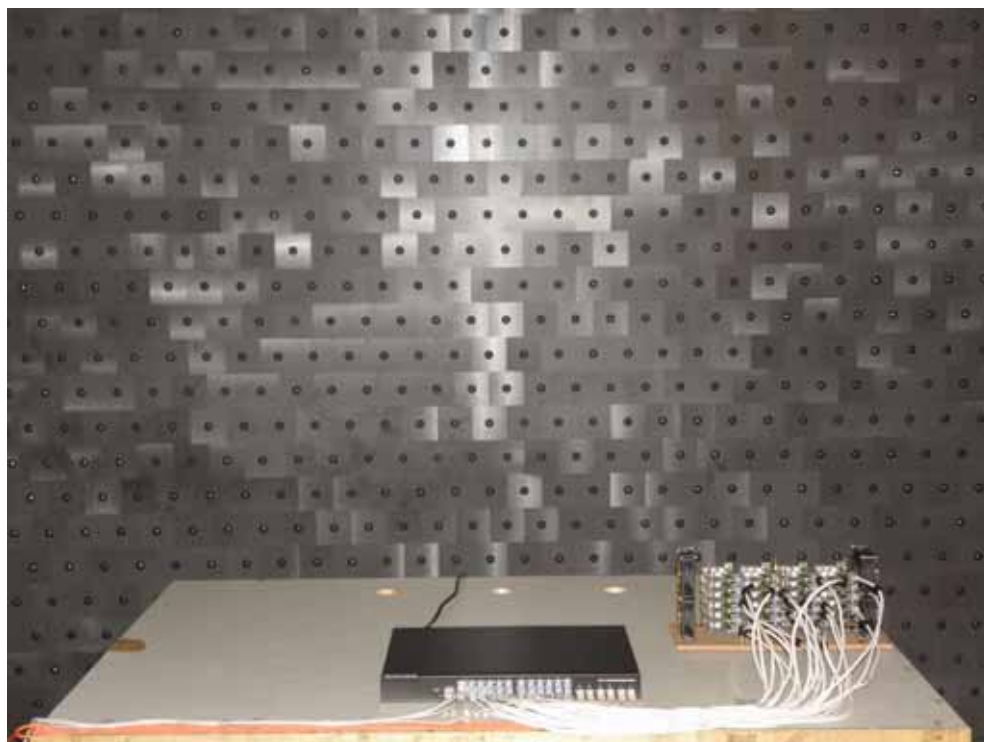

REAR VIEW

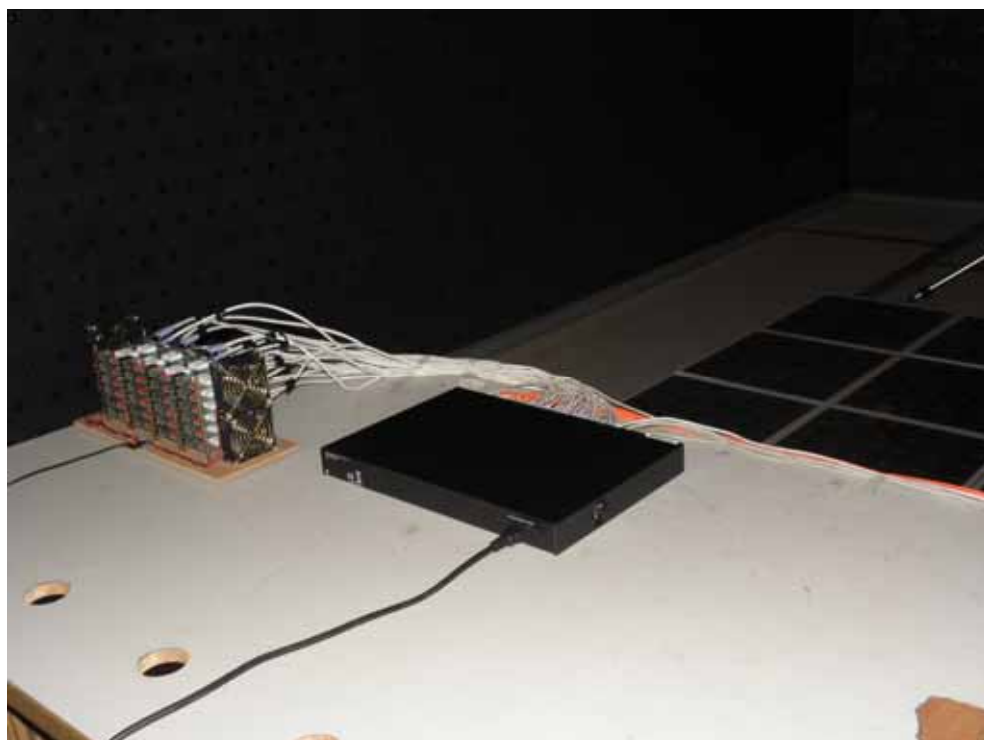

17.6. Photographs of EFT/BURST Immunity Test Configuration

FRONT VIEW



REAR VIEW

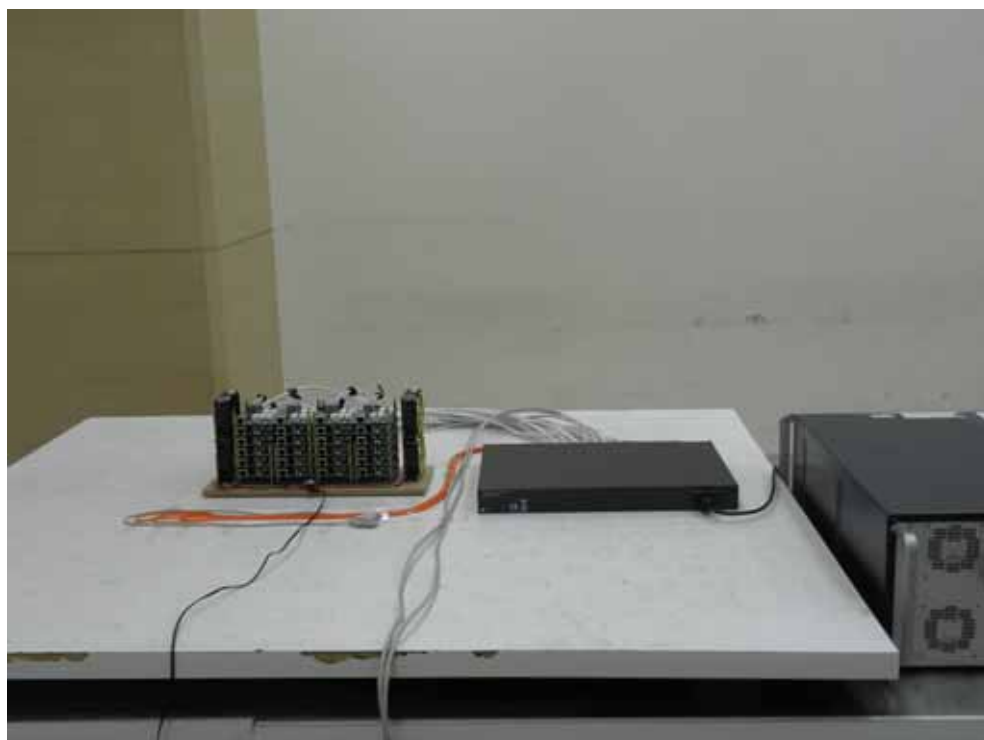

CLAMP

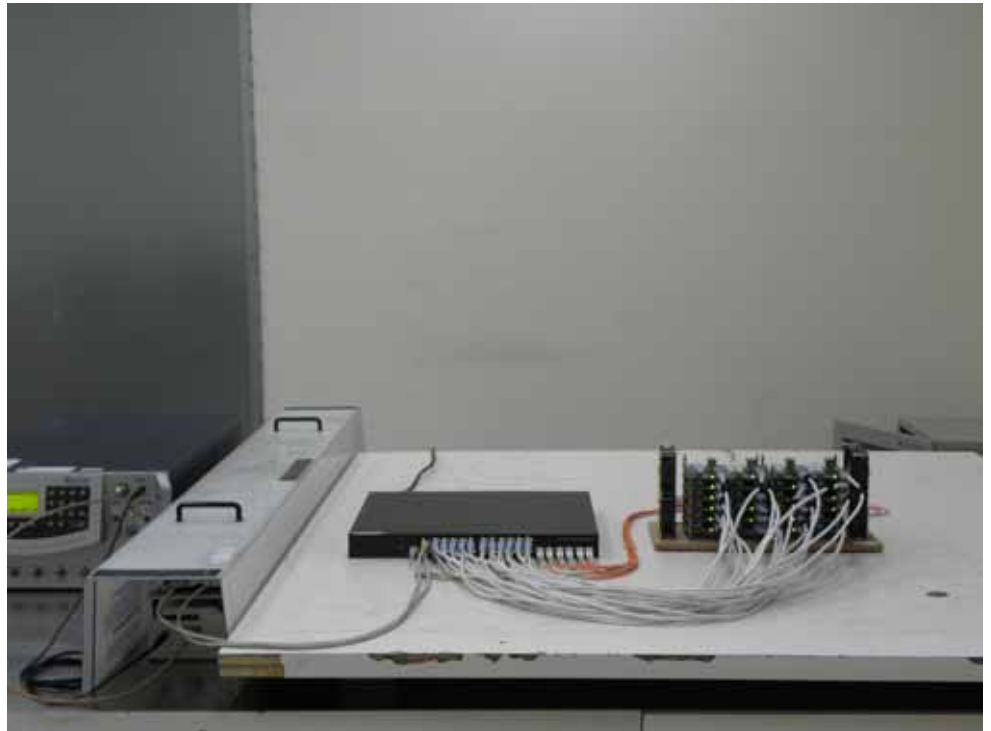

17.7. Photographs of CS Immunity Test Configuration

FRONT VIEW

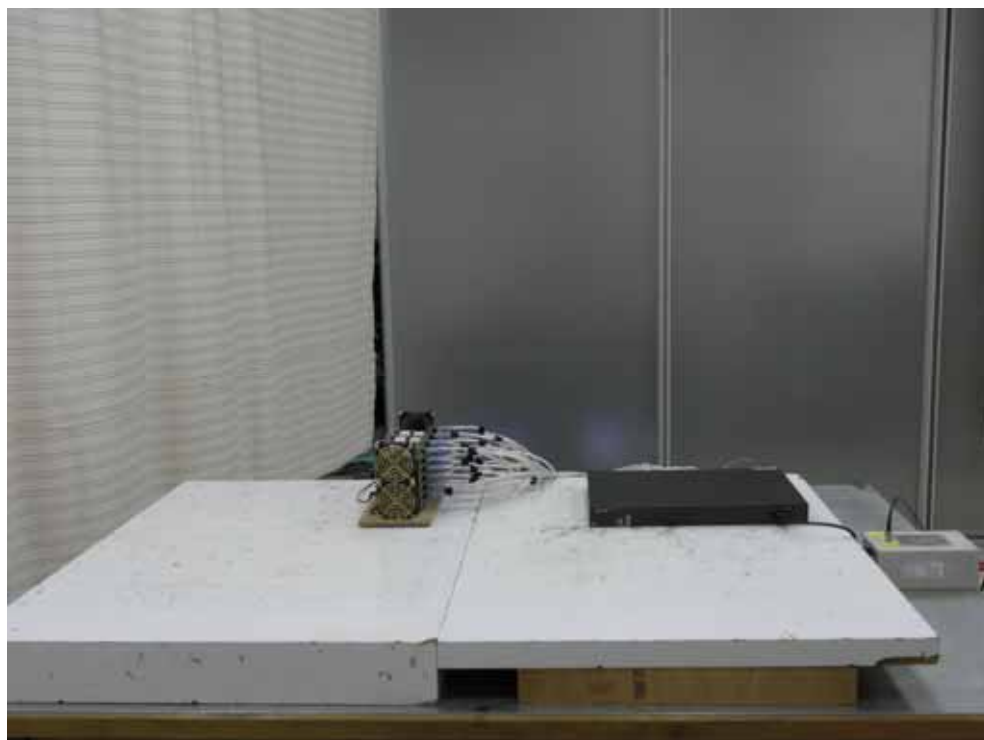

REAR VIEW

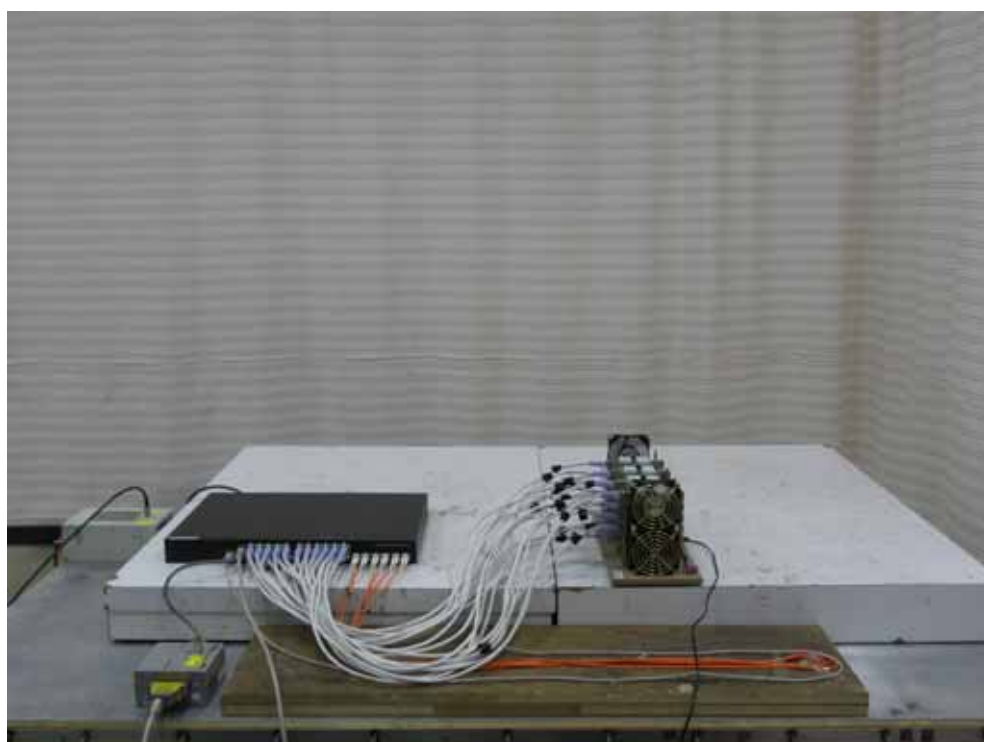

17.8. Photographs of PFMF immunity test Configuration

FRONT VIEW



REAR VIEW

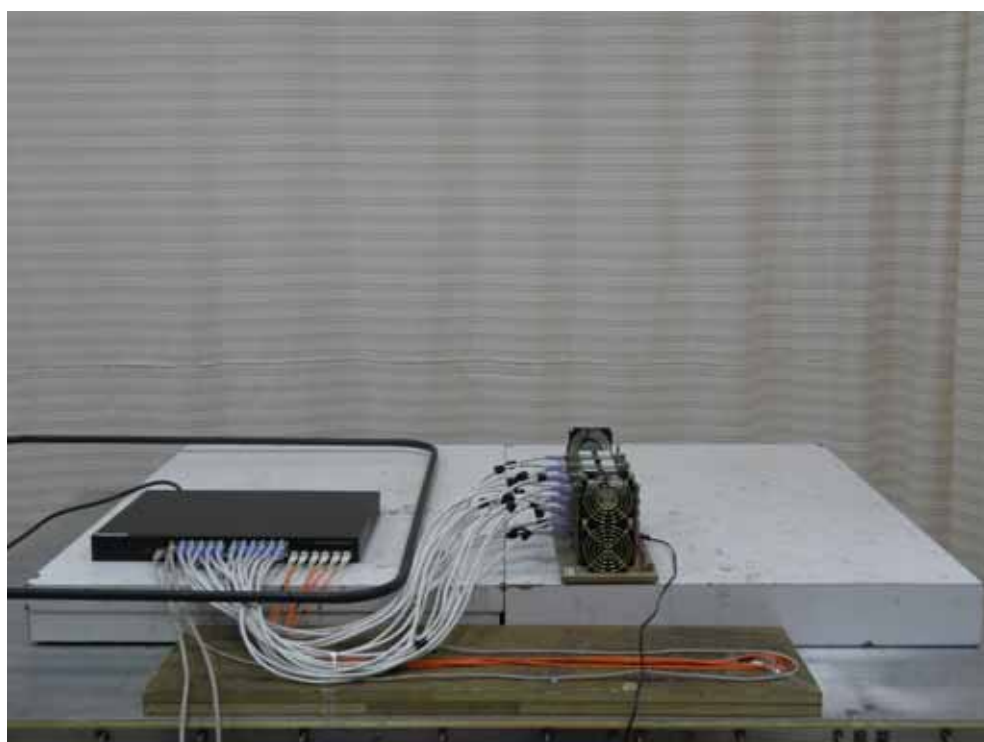

18. List of Measuring Equipment Used

Conducted Emission

Instrument	Manufacturer	Model No.	Serial No.	Characteristics	Calibration Date	Remark
Test Receiver	R&S	ESCS 30	100357	9 kHz ~ 2.75 GHz	Nov. 18, 2011	Conduction (CO01-NH)
LISN	SCHAFFNER	NNB41	04/10053	9 kHz ~ 30 MHz	Nov. 17, 2011	Conduction (CO01-NH)
Power Filter	CORCOM	MR12030	N/A	30A*2	N/A	Conduction (CO01-NH)
RF Cable-CON	Suhner Switzerland	RG223/U	CB004	9 kHz ~ 30 MHz	Dec. 13, 2011	Conduction (CO01-NH)
Impedance Stabilization Network	TESEQ GMBH	ISN T800	26105	150 kHz ~ 30 MHz	Sep. 19, 2011	Conduction (CO01-NH)

Note: Calibration Interval of instruments listed above is one year.

Radiation Emission Below 1GHz

Instrument	Manufacturer	Model No.	Serial No.	Characteristics	Calibration Date	Remark
Open Area Test Site	SPORTON	OATS-10	OS02-NH	30 MHz - 1 GHz 10m, 3m	Jan. 02, 2012	Radiation (OS02-NH)
Amplifier	BURGEON	BPA-530	100203	0.01 MHz - 3 GHz	May 24, 2011	Radiation (OS02-NH)
Receiver	R&S	ESCI	100497	9 kHz - 3 GHz	Apr. 17, 2012	Radiation (OS02-NH)
Bilog Antenna	CHASE	CBL6122B	2884	30 MHz - 2 GHz	Feb. 11, 2012	Radiation (OS02-NH)
Turn Table	EMCO	2080	9508-1805	0 - 360 degree	N/A	Radiation (OS02-NH)
Antenna Mast	ETS	2075-2	2385	1 m - 4 m	N/A	Radiation (OS02-NH)
RF Cable-R10m	MIYAZAKI	5DFB	CB044	30 MHz - 1 GHz	Sep. 16, 2011	Radiation (OS02-NH)

Note: Calibration Interval of instruments listed above is one year.

Radiation Emission Above 1GHz

Instrument	Manufacturer	Model No.	Serial No.	Characteristics	Calibration Date	Remark
Amplifier	Agilent	8449B	3008A02120	1GHz ~ 26.5GHz	Aug. 08, 2011	Radiation (03CH03-HY)
Horn Antenna	EMCO	3115	6741	1GHz ~ 18GHz	May 30, 2011	Radiation (03CH03-HY)
RF Cable-high	SUHNER	SUCOFLEX 106	03CH03-HY	1GHz ~ 40GHz	Jan. 18, 2012	Radiation (03CH03-HY)
Receiver	R&S	ESI	838496/008	20Hz ~ 7GHz	Apr. 24, 2012	Radiation (03CH03-HY)

Note: Calibration Interval of instruments listed above is one year.

EMS

Instrument	Manufacturer	Model No.	Serial No.	Characteristics	Calibration Date	Remark
ESD Generator	TESEQ AG	NSG 437	192	Air: 0KV~30KV Contact: 0KV~15KV	Oct. 07, 2011	ESD
Amplifier	AMPLIFIER& RESEARCH	250W1000A	0325368	80MHz~1GHz	Sep. 09, 2011	RS
DUAL DIRECTIONAL COUPLER	FARNKONIA	FLH200/100	1127	80MHz~1GHz	Sep. 07, 2011	RS
S.G.	ROHDE& SCHWARZ	SML03	103349	9kHz~3.3GHz	Sep. 08, 2011	RS
METER	HP	438A	3513U04050	100kHz~26.5GHz	Sep. 08, 2011	RS
POWER Sensor	HP	8481D	3318A13140	10MHz~18GHz	Sep. 08, 2011	RS
POWER Sensor	HP	8482A	3318A26464	100kHz~4.2GHz	Sep. 08, 2011	RS
Attenuator	HP	8491A	53603	3dB	N/A	RS
EMC PRO System	KEYTEK	EMC PRO	0609221	0KV~4.4KV	Oct. 17, 2011	EFT
EFT/Clamp	KEYTEK	CCL-4/S	0303191	0KV~1KV	N/A	EFT
SURGE Generator Bi-Wave	KEYTEK	EMC PRO	0609221	0KV -6KV/2Ω 0V-500V/12Ω	Oct. 17, 2011	SURGE
SURGE/CDN	EMC -PARTNER	CDN	UTP-8	0.5KV~6kV	Aug. 20, 2011	SURGE
Conducted Immunity Test System	SCHAFFNER	NSG2070	1091	100KHz~250MHz FM 1KHZ 80%	Apr. 12, 2012	CS
Attenuator	EM TEST	75W-DC-250 MHz 06	0004166A	150kHz~230MHz	Apr. 16, 2012	CS
Koppel- Eutkoppelnetzwerk	FRANKONIA	CDN M2+M3	A3011018	150kHz~230MHz	Apr. 17, 2012	CS
Coupling/Decoupling Network	SCHAFFNER	T800	28632	150kHz~230MHz	Apr. 17, 2012	CS
Magnetic Field Antenna	FCC	F-1000-4-8/9/10-L-1M	9830	0~125A	Apr. 12, 2012	Magnetic
Magnetic Generator	FCC	F-1000-4-8-G-125A	05004	0~125A	Apr. 12, 2012	Magnetic
EMC PRO System	KEYTEK	EMC PRO	0609221	230VA/50Hz/60Hz 0% Open/5Sec 0% Short/5Sec 40% 0.10Sec 70%/ 0.01Sec	Oct. 17, 2011	DIP
Harmonic/Flicker Test System	EMC PARTNER	Harmonics -1000	088	4000VA 16A PEAK	Sep. 15, 2011	Harmonics, Flicker

Note: Calibration Interval of instruments listed above is one year.

19. Uncertainty of Test Site

Emission Test Measurement Uncertainty

Uncertainty of Conducted Emission Measurement from 150kHz to 30MHz

Contribution	Uncertainty of x_i		$u(x_i)$
	dB	Probability Distribution	
Receiver reading	0.20	Normal(k=2)	0.10
Cable loss	0.19	Normal(k=2)	0.10
AMN insertion loss	2.50	Rectangular	0.63
Receiver Spec	1.50	Rectangular	0.43
Site imperfection	1.75	Rectangular	1.01
Mismatch	+0.44/-0.46	U-shape	0.32
combined standard uncertainty $U_c(y)$			1.31
Measuring uncertainty for a level of confidence of 95% $U=2U_c(y)$			2.62

Uncertainty of Radiated Emission Measurement from 30MHz to 1000MHz

Contribution	Uncertainty of x_i		$u(x_i)$
	dB	Probability Distribution	
Receiver reading	0.27	Normal(k=2)	0.14
Antenna factor calibration	0.92	Normal(k=2)	0.46
Cable loss calibration	0.16	Normal(k=2)	0.08
Pre Amplifier Gain calibration	0.17	Normal(k=2)	0.09
RCV/SPA specification	2.50	Rectangular	0.72
Antenna Factor Interpolation for Frequency	1.00	Rectangular	0.29
Site imperfection	1.99	Rectangular	1.15
Mismatch	+0.50/-0.54	U-shaped	0.37
combined standard uncertainty $U_c(y)$			1.52
Measuring uncertainty for a level of confidence of 95% $U=2U_c(y)$			3.04

Uncertainty of Radiated Emission Measurement from 1 GHz to 6 GHz						
Input quantity	X_i	Uncertainty of x_i		$u(x_i)$	c_i	$c_i u(x_i)$
		dB	Probability distribution function	dB		dB
Spectrum reading	V_r	± 0.1	k=1	0.10	1	0.10
Attenuation: antenna-receiver	L_c	± 0.1	k=2	0.05	1	0.05
Receiver corrections:	δRC	± 1.0	k=2	0.50	1	0.50
Antenna factor	AF	± 1.3	k=2	0.65	1	0.65
Horn antenna corrections:						
AF frequency interpolation	δAF_f	± 0.5	Rectangular	0.29	1	0.29
AF height deviations	δAF_h	± 0.5	Rectangular	0.29	1	0.29
Directivity difference	δA_{dir}	± 1.0	Rectangular	0.58	1	0.58
Phase centre location	δA_{ph}	± 1.0	Rectangular	0.58	1	0.58
Cross-polarization	δA_{cp}	± 0.9	Rectangular	0.52	1	0.52
Mismatch: antenna-receiver	δM	+0.9/-1.0	U-shaped	0.67	1	0.67
Site corrections						
Site imperfections	δSA	± 5.6	Triangular	2.29	1	2.29
Measurement system repeatability	R	± 0.20	Rectangular	0.117	1	0.117
Cable loss	C	± 0.68	Rectangular	0.394	1	0.394
Preamplifier factor	PA	± 0.06	Rectangular	0.037	1	0.037
					$u_c(y)=$	2.7
					$2 u_c(y)=$	5.4



Immunity Test Measurement Uncertainty

ESD Immunity (IEC 61000-4-2)

Negative Discharge Current

From Standard			
2kV	First Peak Current	Current at 30ns	Current at 60ns
Nominal	7.5	4	2
Min	6.75	2.8	1.4
Max	8.25	5.2	2.6
Tolerance in %	10%	30%	30%

From calibration certificate					
Measured First Peak Current	1st Peak Worst case. +5%	Measured Current at 30ns	30ns Worst case. +5%	Measured Current at 60ns	60ns Worst case. -5%
7.48	7.85	4.2	4.41	2.01	2.11
	6.75		2.8		1.4
	8.25		5.2		2.6

4kV	First Peak Current	Current at 30ns	Current at 60ns
Nominal	15	8	4
Min	13.5	5.6	2.8
Max	16.5	10.4	5.2
Tolerance in %	10%	30%	30%

First Peak Current	1st Peak Worst case. +5%	Measured Current at 30ns	30ns Worst case. +5%	Measured Current at 60ns	60ns Worst case. +5%
15.12	15.88	8.03	8.43	3.68	3.86
	13.5		5.6		2.8
	16.5		10.4		5.2

6kV	First Peak Current	Current at 30ns	Current at 60ns
Nominal	22.5	12	6
Min	20.25	8.4	4.2
Max	24.75	15.6	7.8
Tolerance in %	10%	30%	30%

First Peak Current	1st Peak Worst case. -5%	Measured Current at 30ns	30ns Worst case. +5%	Measured Current at 60ns	60ns Worst case. +5%
22.78	23.92	12.37	12.99	5.45	5.72
	20.25		8.4		4.2
	24.75		15.6		7.8

8kV	First Peak Current	Current at 30ns	Current at 60ns
Nominal	30	16	8
Min	27	11.2	5.6
Max	33	20.8	10.4
Tolerance in %	10%	30%	30%

First Peak Current	1st Peak Worst case. +5%	Measured Current at 30ns	30ns Worst case. +5%	Measured Current at 60ns	60ns Worst case. +5%
30.26	31.77	16.13	16.94	7.39	7.76
	27		11.2		5.6
	33		20.8		10.4

Negative Discharge Voltage

Standard Parameters				Measured Values
Indicated Voltage.	Tolerance.	Max.	Min.	
kV	%	kV	kV	kV
2	10	2.20	1.80	2.05
4	10	4.40	3.60	4.027
6	10	6.60	5.40	5.955
8	10	8.80	7.20	7.916
15	10	16.50	13.50	14.839

Negative Rise Time

Standard Parameters		Measured Values			
T max.	T min	Indicated Voltage.	Measured Rise Time.	Worst Case max. +6%	Worst Case min. -6%
1ns	0.7ns	2kV	0.851	0.902	0.799
		4kV	0.780	0.268	0.733
		6kV	0.750	0.795	0.705
		8kV	0.772	0.818	0.726

It has been demonstrated that the ESD generator meets the specified requirements in the standard with at least a 95% confidence

RF Radiated Immunity (IEC 61000-4-3)

Symbol	Source of Uncertainty	Value	Probability distribution	Divisor	ui(y)
FSM	Felds Strength monitor	1.5	Normal 2	2.000	0.75
FSAW	Field Strength acceptability window	0.50	Rectangular	1.732	0.29
PAH	Power Amplifier Harmonics	0.50	Rectangular	1.732	0.29
RS	Measurement System Repeatability	0.50	Normal 1	1.000	0.50
REUT	Repeatability of EUT	0.00	Normal 1	1.000	0.00
uc(FS)	Combined Standard Uncertainty		Normal		0.83
U(FS)	Expanded Uncertainty		Normal k= 2		1.66

Specified Level (V/m)	Test level (V/m)
For 1 Volts	1.25
For 3 Volts	3.33
For 10 Volts	11.22

RF Conducted Immunity (IEC 61000-4-6)

Symbol	Source of Uncertainty	Value	Probability distribution	Divisor	$u_i(y)$
S_A	Spectrum Analyzer	1.50	Rectangular	1.732	0.87
C_C	Current coil Calibration	1.00	Normal 2	2.000	0.50
M	Mismatch	-0.5	U-shaped	1.414	-0.35
M	Mismatch	-0.3	U-shaped	1.414	-0.35
R_S	Measurement System Repeatability	0.50	Normal 1	1.000	0.50
R_{EUT}	Repeatability of EUT	0.00	Normal 1	1.000	0.00
$u_c(F_S)$	Combined Standard Uncertainty		Normal		1.57
$U(F_S)$	Expanded Uncertainty		normal k= 2		3.14

Specified Level	Test level (V)
For 1 Volts	1.30
For 3 Volts	3.88
For 10 Volts	12.15

20. Notice for Class A Product

This Notice is for class A product only. If the Equipment under Test is a class B product, this notice should be disregarded.

Class A ITE is a category of all other ITE which satisfies the class A ITE limits but not the class B ITE limits. Such equipment should not be restricted in its sale but the following warning shall be included in the instructions for use:

Warning

This is a class A product. In a domestic environment this product may cause radio interference in which case the user may be required to take adequate measures.

APPENDIX A. Photographs of EUT









